

Principals, structure properties and preparation methods of ointments

Institute of Pharmaceutical Technology and Biopharmacy

The usage of ointment has a long history. Notes on the Ebers papyrus were found about ointments.

- 1828.: - White vaseline was synthesized from the evaporation leftover of crude oil in Cheseborough
- 1858.: - Production of glycerol gelled by starch
- 1885.: - Production of purified wool grease (Liebrlich).
- 1936.: - Quantitative determination of water number in case of W/O emulsion-based ointments
- 1941.: - Thixotropic nature of methyl-cellulose → Gel can be manufactured with methyl-cellulose, which has a thixotropic property.
- 1949.: - Introduction of polyethylene-glycol as a basic ointment material→
Unguentum macrogoli.
- 1953.: - **The ointments are gels** → coherent frame, which fixes liquid

- 1962.: **Mathematic model of liberation** → With it, ointments can be classified, compared to each other
- 1963.: **Rheological examinations**
- 1965.: Description of penetration accelerator excipient and majority of excipients used in ointments
(consistency providing, manufacture promoting etc.)
- 1969.: Microscopic examination of ointments, theory of complex emulgents of creams and liquid crystal theory.
- 1974.: Process sections of created dermal effect
- 1975.: Introduction of transdermal delivery systems (TDS)
Liquid crystal ointment basic materials → not only API is got into skin, but the liquid crystals too.

The definition of ointments is a generic term, because different structure having semisolid systems are involved.

(ie. hydrocarbon structures,
lipogel structures,
emulsion-based structures,
macromolecular structures)

- Ointments have well-defined colloidal structures
- Their deformation behaviors can be described exactly, and specified by exact figures (plastic, pseudoplastic, thixotropic yield, yield point).

Semi-solid preparation for cutaneous application

(PRAEPARATIONES MOLLES AD USUM DERMICUM) (Ph.Eur. IV.)

„Semi-solid preparations for cutaneous application are intended for *local or transdermal* delivery of active substance or for their emollient or protective action. They are of homogeneous appearance.

Semi-solid preparations of cutaneous application consist of a simple or compound basis in which usually 1 or more active substance are dissolved or dispersed. According to its composition, the basis may influence the activity of preparation.”

CLASSIFICATION OF SEMI-SOLID PREPARATION FOR CUTANEOUS APPLICATION:

- Ointments
- Creams
- Gels
- Pastes
- Poultices
- Medicated plasters

I. OINTMENTS (Ph.Eur.IV.)

An ointment consists of a single-phase basis in which solid or liquid material may be dispersed.

1., Hydrophobic ointments can absorb only small amount of water.

Typical material used for their formulation are:

- hard solid and light liquid paraffins,
- vegetable oils,
- animal fats,
- synthetic glycerides,
- waxes,
- liquid polyalkylsiloxanes.

I. OINTMENTS (Ph.Eur.IV.)

2., *Ointments emulsifying water* :

can absorb larger amount of water and thereby produce water-in-oil or oil-in-water emulsions after homogenization, *depending on the nature of the emulsifiers*:

w/o emulsifying agents: wool alcohols, sorbitan esters, monoglycerides, fatty alcohols

o/w emulsifying agents : sulphated fatty alcohols, polysorbates, macrogol cetostearyl ether or esters of fatty acids with macrogols

Bancroft-rule!

I. OINTMENTS (Ph.Eur.IV.)

3., *Hydrophilic ointments:*

are preparations having bases that are miscible with water.

The bases usually consist of mixture of liquid and solid **macrogols** (polyethylene glycols).

II. Creams (Ph. Eur. IV.)

Creams are multiphase preparations consisting of a lipophilic phase and an aqueous phase.

Lipophilic creams: have as the continuous phase the lipophilic phase. They usually contain **water-in-oil** emulsifying agents as ***wool alcohols, sorbitan esters and monoglycerides.***

(Occlusive barrier)

Hydrophilic creams : have as the continuous phase the aqueous phase. They contain **oil-in-water** emulsifying agents such as:

sodium or trolamine soaps, sulphated fatty alcohols, polysorbates and polyoxyl fatty acid and fatty alcohol esters combined, if necessary with water-in-oil emulsifying agents.

III. Gels (Ph.Eur.IV.)

Gels consist of liquid gelled by suitable gelling agents.

The gels are colloidal coherent structures consisted of colloidal sized high liquid content and inorganic particles or organic macromolecules.

Gels can be:

- transparent gels („monophase“ or „iso“-gels)
- „two-phase“ disperse system gels.

IV. PASTES / Ph.Hg. VII.:

The paste (pasta) is those ointment with high consistency, which consists of (40% or more) powdered medicine materials as a solid disperse phase in it.

Ph.Eur. IV.:

Pastes are semi-solid preparations for cutaneous application containing high proportion of solids finely dispersed in the basis.

V. POULTICES /Ph.Eur.IV.:

Poultices consist of **hydrophilic heat-retentive** basis in which solid or liquid active substance are **dispersed**. They are usually spread thickly on a suitable dressing and **heated** before application to the skin.

VI. MEDICATED PLASTERS/Ph.Eur.IV. :

Medicated plaster are flexible preparations containing 1 or more active substances. They are intended to be applied to the skin. They are designed to maintain the active substance(s) in close contact with skin such that theses may be absorbed slowly, or act protective or keratolytic agent.

THREE AIM OF APPLICATION OF OINTMENTS :

1. To ***protect*** the damaged skin surface
2. To get the skin to be ***hydrated*** or its ***nutrition***
3. To achieve a ***therapeutic treatment*** at the skin, as local or systemic effect.

CLASSIFICATION OF MEDICAL OINTMENTS

The medical ointments can be classified according to many aspect.

According to the nature of effect:

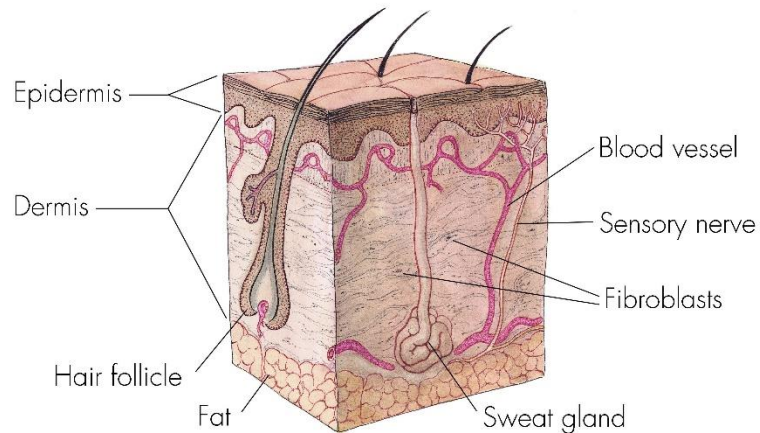

- covering or protective ointments,
- wound ointments,
- ointments capable for penetration,
- ointments capable for resorption.

Principals of absorption through skin

The absorption is carried out by **passive diffusion**.

The percutaneous absorption can be divided into 4 steps:

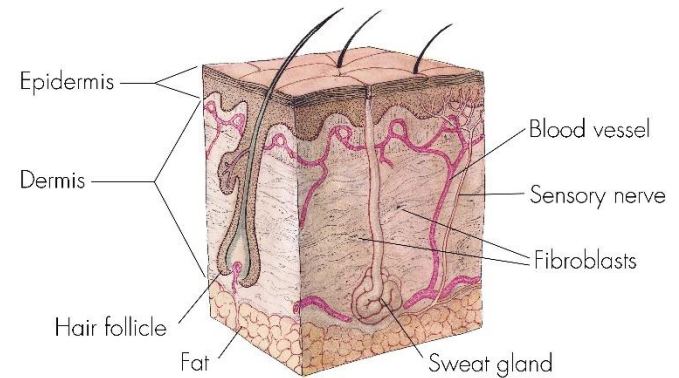

1. **liberation**: API diffusion onto skin surface,
2. **penetration**: API diffusion into epidermis,
3. **permeation**: The API diffuses from a layer of skin into another structurally and functionally different layer
4. **resorption**: The approach of systemic circulation by the API.

Ointments

Medical Ointments

Active substance

in -dissolved

- suspended

- emulsified.

Basis (Basic ointment)

(more components)

Basic materials

Excipients

Basic materials: component of basic ointment largest amount in it. (e.g. white vaseline)

Excipients: components of basic ointment in less amount in it (e.g. fatty alcohols, waxes, surfactants)

Basic ointment = Basis

The basic ointments have a complex composition.

SPECIFICATIONS OF OINTMENT STRUCTURE

GENERAL CLASSIFICATION OF GEL STRUCTURE

Specification of coherent structure:

- a., **heterogeneous** coherent structure (particles are stiff discontinues parts)
- b., **colloidal** coherent structure (**gels**) (colloid sized particles)

According to formation, gels can be :

- **desolution** (from homogeneous disperse structure by decrease of solubility)
- **coagulation type** (from well solvated colloidal disperse structures by desolvation)
- **swollen type** (macromolecules)
- **chemogels** (by chemical interaction)

SPECIFICATIONS OF OINTMENT STRUCTURE
GENERAL CLASSIFICATION OF GEL STRUCTURE

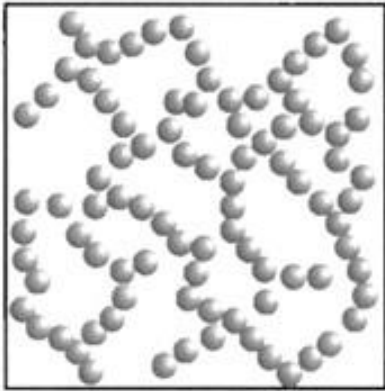

a

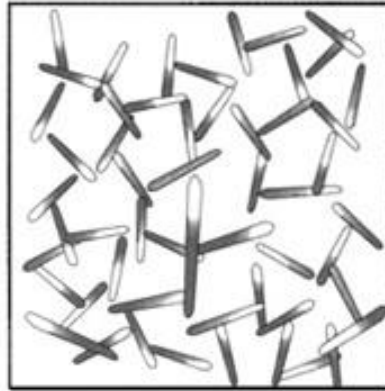

b

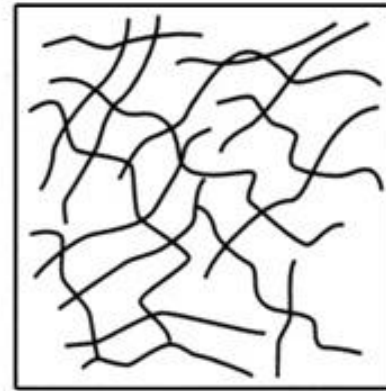

c

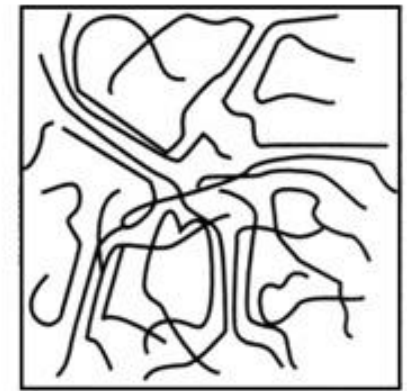

d

Models of gel structure

- a: structure frame built with orb shape colloid particles
such as: gel of colloidal silica in aqueous area**
- b: frame consisted of anisodimensional particles (bentonite gel)**
- c: frame built with fiber, yarn shape particles (soap gel)**
- d: gel structure of macromolecules contained crystal or amorphous shape particles
such as micelle**

Preparation method of ointments

Institute of Pharmaceutical Technology and Biopharmacy

Excipients of ointments

1. Basic components:

- hydrophilic and lipophilic gel-forming
- o/w, w/o emulsifying agent
- complex emulsifying agent
- components of liquid phase.

2. Agents influencing consistency :

- viscosity increasing excipients
- humectant materials.

3. Stability providing agents:

- antioxidants
- microbiological preservatives.



4. Excipients applied with a biopharmaceutical purpose:

- Liberation assisting agents
- Penetration assisting agents
- Penetration increasing agents.

ASPECT OF CHOICE OF BASIC MATERIALS:

- Properties of active substance (solubility, dispersion property)
- Syndrome (acute / chronic)
- Desired effect (local / systemic)
- Nature of basic ointments.
- Bioavailability of active substance
- Stability of basic materials.

Indication

- Short-term application  creams,
- Long-term application  ointments
- Effect development time:
hydrogel < o/w emulsion-based < w/o emulsion-based basic ointment

ASPECT OF CHOICE OF BASIC MATERIALS:

Hydrocarbon bases are used (vaseline), when:

- active substance has an irritative effect on skin
- aim is to achieve surface effect.

Lipogel bases are used (Ung. oleosum), when:

- active ingredient is soluble in this lipoid media,
- aim is to achieve effect deeper.

Polyethylene-glycol bases are used (e.g. Ung. macrogoli), when

- patient is sensitive to lipoid materials,
- active substance is rather soluble in hydrophilic area.

ASPECT OF CHOICE OF BASIC MATERIALS:

W/o emulsion-type bases are used (e.g. Ung. hydrosum, Ung.emolliens), when

- active substance is well soluble both in aqueous and lipid
- slow, prolonged effect is needed.

O/w emulsion-type bases are used (e.g. Ung. hydrophilicum non- and anionicum) when:

- active substance is soluble in aqueous area.

Hydrogel bases are used (e.g. Hydrogelum methylcellulosi) when:

- patient is sensitive to lipid
- active substance is soluble in aqueous area.

Preparation requirements:

Multicomponent water-free ointment materials can be generally **melted** together during the preparation process.

In case of need it has to be filtered.

The molten materials have **to be mixed until it totally cools down**, and if it is possible, have to be **homogenized on the other day**.

(in case of larger quantity prepared in pharmacy)

Preparation requirements:

W/o type of emulsion-based ointments is prepared with softening (melting is not needed), or currently melting the fatty phase, then in this status the aqueous phase is being emulsified on **the same temperature** as the just **molten/ softened** fatty phase. The preparation is mixed until total cooling down.

When if it is possible the preparation should be homogenized on the other day. (in case of larger quantity prepared in pharmacy)

Preparation requirements:

At the preparation of O/W type emulsion-based ointments the aqueous phase is emulsified in small parts on appropriately **same temperature (rather warmer)** as the molten fatty phase

The ointment has to mixed until cooling down.

The evaporated water has to be supplemented after preparation procedure!!!

The O/W type emulsion-based ointments can only filled into plastic container, when it is **totally cooled**.

Preparation requirements:

If solution of active substance can not be prepared, then as a fine powder (**160 μm**) with a geometric dilution is suspended with the particle part of the ointment material, with inert liquid properly to the consistency for ointment.

The suspension-based ointment must always be prepared in **mortar**.

If a wet grinding agent is needed, it can be used but the quantity of excipients has to subtract form the ointment material.

PREPARATION OF OINTMENTS

- The **solution-based** and **emulsion-based** ointments in **patendula**,
- The **suspension-based** ointments must be prepared in **mortar**.

ERWEKA ointment mixer



Planetary mixer, mixer topping



TRIPLE ROLL MILL

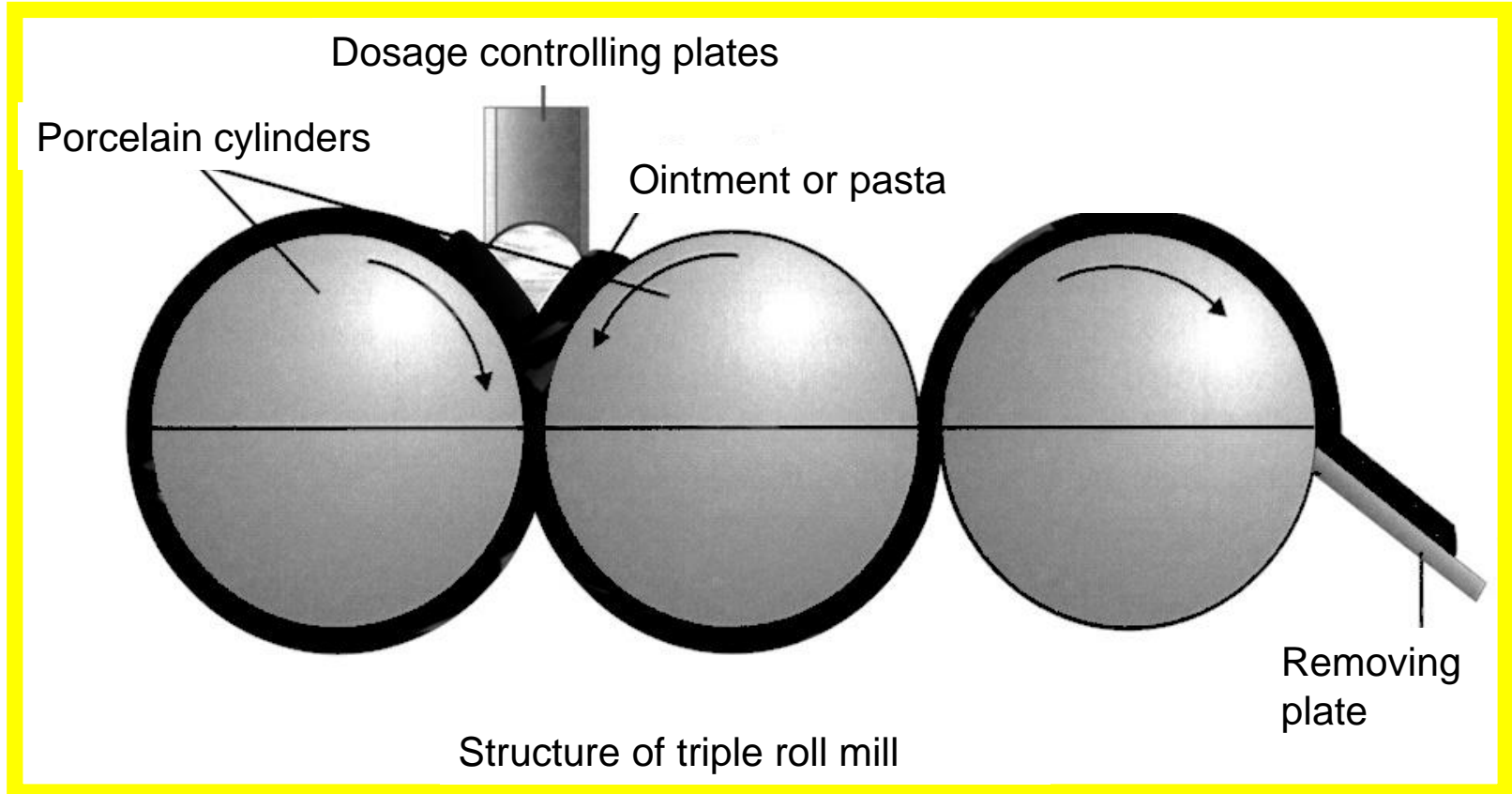

Unguator

type: 2100



- **Automated control with lifting arm**
- For compounding preparation at the amount of 15ml - 1000ml .
- Pre-programmed, but manually the RPM can be also adjusted till **3000 U/min.**
- Besides the ointment, it is **suitable for gels and suppositories too.**
- The preparation method of compounding preparation occurring in pharmacy are almost 100% programmed.
- 3 bottom push to start mixing.
- The quality of product is always the same because of the integrity of microprocessor .
- It can be controlled and remoted by the an optional UNGUATOR Assist-Software

Basic ointments of Ph. Hg.VII./ GALENICALS:

- Unguentum aluminii acetici tartarici
- Unguentum argenti nitrici
- Unguentum emolliens
- Unguentum emulsificans anionicum
- Unguentum emulsificans nonionicum
- Unguentum glycerini
- Unguentum hydrophylicum anionicum
- Unguentum hydrophylicum nonionicum
- Unguentum hydrosum
- Unguentum macrogoli
- Unguentum oleosum
- Unguentum paraffini
- Unguentum simplex
- Unguentum stearini
- Unguentum zinci oxydati
- Vaselinum acidi borici

Ointment materials and stability of ointments

Institute of Pharmaceutical Technology and Biopharmacy

CLASSIFICATION OF OINTMENTS AND OINTMENT MATERIALS

According to dispersion of API (in case of therapeutic ointments):

- 1., solution-based
- 2., emulsion-based,
- 3., suspension-based.

According to the location of application:

- 1., on skin,
- 2., on eye,
- 3., on wound,
- 4., on mucosa.

According the area of created effect:

- 1., local,
- 2., systemic.

CLASSIFICATION OF BASIC OINTMENTS

According to Münzel

1. Hydrocarbon-gels
2. Lipogels
3. Hydrogels
4. Polyethylene glycol-gels
5. Silicone-gels



**Oil-in
Water
(Hydrophilic
Ointment)**



**Water-in
Oil
(Eucerin)**



**Anhydrous
Absorption
(Aquaphor)**



**Hydrocarbon
(White
Petrolatum)**

Examples for ointment materials

Hydrocarbon gels:

- Vaselinum album
- Unguentum paraffini
- Unguentum silicoparaffini
- Unguentum emulsificans

Ointment materials capable for absorption:

- Ung. simplex (+ water → Ung hydrosum - w/o)
- Ung. oleosum (+ water → Ung. emolliens - w/o)

Ointment materials miscible with water (O/W EMULSION-TYPE):

- Ung. hydrophylicum anionicum, nonionicum.
- Ung. glycerini
- Ung. stearini

Water-soluble ointment materials:

- Ung. macrogoli
- Hydrogelum methylcellulosi
- Hydrogelum hydroxyaethylcellulosi

REQUIREMENTS OF OINTMENT MATERIALS

Requirements of ointment materials according usage:

- 1., compatibility
- 2., good penetration ability,
- 3., do no harm,
- 4., good rubbing capability,
- 5., its pH does not differ significantly from the pH on the application area,
- 6., miscible property with water or water based solutions,
- 7., odorless or it has a mild smell,
- 8., during the storage does not change (stability).

Ointment materials

I. Water-free ointment materials

1. Hydrocarbon gels

a. Medical vaseline:

- 1871. Cheseborough
- Vaseline has been used since 1878
- hydrocarbon gel with coherent structure
- Its components: - *solid (10-30%)*

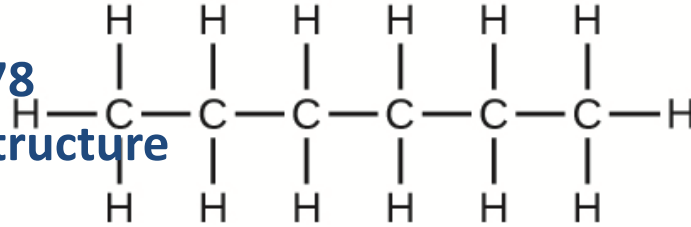

(crystallized - normal paraffins
microcrystallized - amorphous isoparaffin)

- *liquid (70-90%)*

(normal or isoparaffins).

- micelles (polarization microscope, electron microscope)
- The rheological properties are determined by the proportion of isoparaffin and paraffin
- The presence of isoparaffin is required for thixotropic regeneration

Ointment materials

I. Water-free ointment materials

1. Hydrocarbon gels

$$\text{Oil number („bleeding number”)} = \frac{\text{liquid separated after heat stress}}{\text{mass of ointment sample}} \times 100$$

Reason: **syneresis**= the gel structure shrinks after particular time and the mechanically bounded liquid separates from the structure.

Ointment materials

I. Water-free ointment materials

1. Hydrocarbon gels

a, Medical vaselin:

Advantages:

- indifference,
- no emulsifying property,
- water absorbing ability \emptyset ,
- emulsion can prepared with appropriate o/w or w/o emulsifying agent
- surface effect

Disadvantages:

- skin is totally, hermetically covered
- skin irritation, inflammation can be caused after a long-term use,
- API liberation is not appropriate,
- not relevant for resorption ointment,
- can not be washed off,
- can not applied in hairy head skin.

Ointment materials

I. Water-free ointment materials

1. Hydrocarbon gels

Official vaselines of Ph. Eur. VI:

- ***Vaselineum album*** (white vaseline): whitened mixture of saturated, opened chains of carbohydrates prepared from crude petroleum.
- ***Vaselineum album ophthalmicum*** (ophthalmic white vaseline): very viscose, pure white vaseline, from which threads can be drawn .(isoparaffins)
- ***Vaselineum flavum*** (yellow vaseline): mixture of saturated, opened chains of carbohydrates prepared from crude petroleum. Yellow-colored.

Ointment materials

I. Water-free ointment materials

1. Hydrocarbon gels

Simple hydrocarbon-gels: Vaselineum album,

Absorption-type carbohydrate-gel: Ung. simplex,
Oculentum simplex,

Solution-based carbohydrate-gels: camphor containing ointm.

Suspension--based carbohydrate-gels: Ung. zinci oxydati,
Vaselineum acidi borici

Emulsion-based carbohydrate-gels: Ung. hydrosum,
Oculentum hydrosum,
Ung. alumininii acetici tartarici

Ointment materials

I. Water-free ointment materials

2. Lipogels

- natural animal fats
- hydrogenated vegetable oils
- complex lipogels
- oleogels.

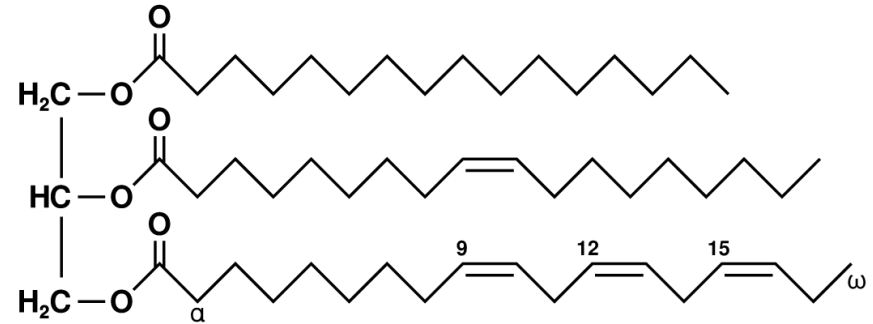

- The oldest applied ointment materials.
- Mixture of grease consisting **triglycerides** and **wool wax (Cera lanæ)**, **beeswax (Cera alba)**, **vegetable oils**.
- **Advantage:**
 - chemically not extraneous for body
 - physiological processes are not inhibited ,
 - capable for penetration,
- **Disadvantage:** can become rancid.

Ointment materials

I. Water-free ointment materials

2. Lipogels

a. Adeps suillus (Axungia porci, porcine fat)

- water can be absorbed as much as the 20% of ointment
- excellent emollient property
- the physiological processes of skin is not inhibited,
- melting point is around body temperature,
- good drug delivery ability,
- easily can become rancid.

Ointment materials

I. Water-free ointment materials

2. Lipogels

b. Hydrogenated vegetable oils:

- the affected hydrogenation results in a hardened consistency (becoming saturated, cis-trans alternation)

- Oleum arachidis hydrogenatum:

[peanut (*Arachis hypogaea*)]

its consistency hardened with time.

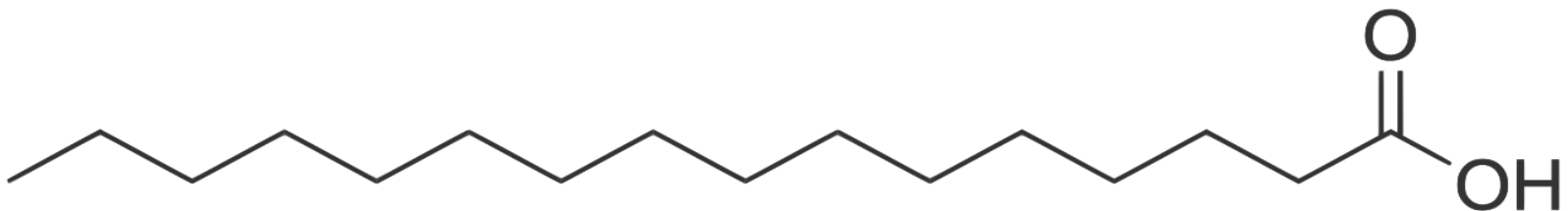

Ointment materials

I. Water-free ointment materials

2. Lipogels

c. Complex lipogels:

Preparation: with the melting the liquid oils and solid lipids into each other, and then with the mixture until it totally cools down.

Main components:

beeswax, wool wax, fat alcohols, spermaceti
vegetable oils.

Waxes: summary term of several consistency increasing natural and artificial materials. (on 20 °C are they solid, on ~40 °C melt.)

natural waxes: wool wax, beeswax,
paraffin wax, montan wax.

semi-synthetic waxes: microcrystalloid paraffin,

Ointment materials

I. Water-free ointment materials

2. Lipogels

c. Complex lipogels (ie. Unguentum oleosum):

Fatty alcohols:

- cetearyl and stearyl alcohols
- official as a mixture in the Ph. Eur. IV.,
- fat components are gelled by fat alcohols
- assist to harden the consistency
- excellent emulsifying property.

Liquid oils:

- play the role as a liquid phase of gel,
- their amount can be even 60-90%,
- ricin oil, peanut oil, coconut oil, olive oil, isopropyl-myristate, isopropyl-stearate.

Ointment materials

I. Water-free ointment materials

3. Silicone-gels

- Silicones are created polymers of silicium and oxygen atoms.
- Silicon gels create a film layer on the surface of skin.
- The physiological features of skin is not inhibited.
- Applied in protective or covering ointments.
- Silicone gels make the skin more resistant against water or other liquids.
- **Usual composition:** silicone paste + oils.

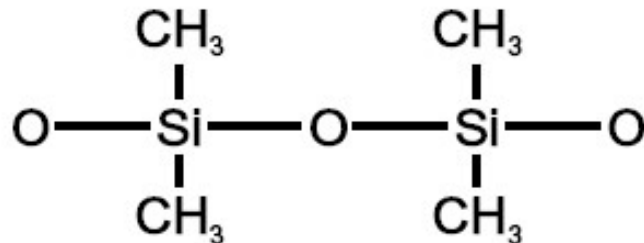

Ointment materials

I. Water-free ointment materials

4. Polyethylene glycol-gels

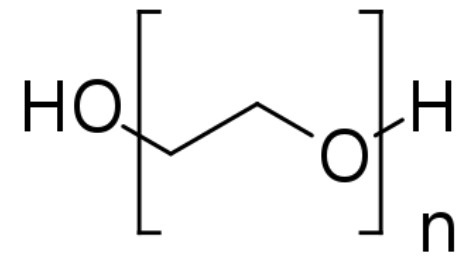

- Macrogolum „400, 1540, 4000”; Polywax, Carbowax, PEG, PAÖ
- Polyoxaethenum, Polyaethylenglycolum
- HO-CH₂-(CH₂-O-CH₂)_n-CH₂-OH
- Synthesized by the polymerization of ethylene-oxide, or condensation of ethylene-glycol.
- Prepared by melting together macrogols with different molecular mass and different aggregate (Unguentum macrogoli).
- Coherent structure.
- **Advantage:** they have very favorable properties, don't become rancid, easily rubable property, their adhesion is sufficient, good wash off property, no skin irritation
- **Disadvantage:** osmotically active substances (water absorbing, therefore inhibition of API penetration), the dissolved API can be crystallized in another crystalloid form.
 - reducing property having materials: with mercury salts, sulfonamides result in colorful production, and can dissolve particular plastics or enamels.
- **Bactericide property.** No preservative agent is needed.

Ointment materials

II. Emulsion-based ointment materials

- Majority of ointment materials,
- 30-80% emulsified water content,
- Emulsifying agent in composition
- Soft consistency
- Esthetic appearance
- Have complex coherent structure,
- Excipients are needed.

- ***Classification:***
 1. According to composition:
Materials tend to create emulsions,
Emulsion-type gels (o/w, w/o type).
 2. According to type:
w/o emulsion,
o/w emulsion,
complex (amphiphilic) emulsion,
microemulsion gels.

Ointment materials

II. Emulsion-based ointment materials

1. W/O-type emulsion structures

A, absorption capable ointment materials:

- Yet water-free hydrocarbon gels or lipogels, which consist of W\O emulsifying agent to create emulsion-based ointment .
 - e.g. **Unguentum simplex:** absorption capable hydrocarbon gels
 - Unguentum oleosum:** absorption capable lipogels
- **Emulsifying agents can be:** wool wax, cetyl alcohol, stearyl alcohol, cetostearyl alcohol, cholesterol, glycerol-monostearate.
- Particular quantity of water can be absorbed and kept.
- *Water absorbing ability, water-bounding property, water number.*

Ointment materials

II. Emulsion-based ointment materials

1. W/O-type emulsion structures

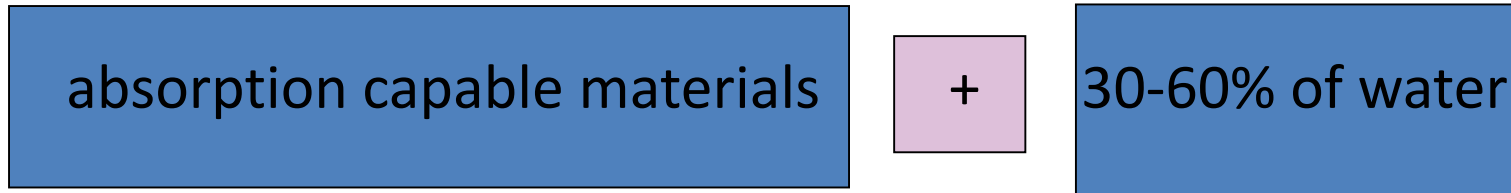

- ie. Unguentum emolliens
Unguentum hydrosum

STABILITY EXAMINATION:

- thermal stress
- with centrifuge

Ointment materials

II. Emulsion-based ointment materials

2. O/W-type emulsion structures

- Multi-components having structures consisted of emulsifying agent with high HLB value and other excipients.
- Unlimitedly miscible with water.
- Emulsion is created by the soap alone.
- Washable with water.
- „hydrophilic cream, washable cream, fat-free cream”
- 60-80% water content.
- **Microbiological preservation is needed!!**

Classification:

- stearate creams,
- complex emulsifying agent containing structures,
- self emulsifying structures,
- liquid crystalloid structures,
- transparent tenzid gels.

Ointment materials

II. Emulsion-based ointment materials

3. Amphiphilic emulsion type structured materials

- This type of ointment materials creates a transition of o/w and w/o structures.
- Can be diluted with both lipophilic and hydrophilic phase too.
- The frame creating amphiphilic material can be:
 - long chain fatty alcohols (cetyl- stearyl-alcohol)
 - partial fatty acid esters of glycerol
(glycerol-monostearate)

Ointment materials

II. Emulsion-based ointment materials

4., Transparent tenside gels (Microemulsion gels)

The liquid **lipophilic phase-tenside-water**, in a particular proportion will not be fluid, but a gel structure will be created having yield points, and plastic formability.

This structure ***requires high concentration of surfactant.***

Ointment materials

III. Macromolecular hydrogels

1. Hydroxy-ethyl-cellulose
2. Methyl-cellulose
3. Carboxy-methyl-cellulose- Sodium
4. Pectin
5. Polyacrilates, polymethacrylates

Ointment materials

III. Macromolecular hydrogels

- **Novel type. (since the 50's)**
- **Gels.**
- **The frame is created by colloidal size organic macromolecules.**
- **80-95% water and 5-20% gelling agent content.**
- **Water-soluble property!**
- **Microbiological preservatives and humectant excipient is required.**
- **Dispensed in tube.**
- **Advantage:**
 - **good drug delivery,**
 - **film creation,**
 - **cooling effect**
 - **protective effect**
 - **cheap**
 - **good adhesion capability**

Ointment materials

III. Macromolecular hydrogels

a, methyl-cellulose:

- Can be wetted with warm water. On 60-90 °C temperature the methyl-cellulose aggregates, for cooling it dissolves again. The cooling assist in swelling.
- Transparent, total homogeneous appearance
- Gelling concentration: **5-10%**.
- Plastic –thixotropic structure.
- Its viscosity does hardly change with temperature.
- Hardly sensible for change in pH
- Dehydration and flocculation can caused by adding cc. etanol, electrolytes.
- Hydrogelum methylcellulosi (Ph.Eur. VI.)

Ointment materials

III. Macromolecular hydrogels

b, hydroxy-ethyl-cellulose:

- Gel structure is even created in room temperature rapidly
- Totally transparent, homogeneous, very esthetic appearance
- **4-15%**
- Stable viscosity

Ointment materials

III. Macromolecular hydrogels

c, Carboxy-methyl-cellulose-sodium:

- **7-10%**
- Swelling does not depend on temperature, cooling
- Anionic type polyelectrolyte
- Incompatibility with heavy metals, cations, hydrochloric acid

Ointment materials

III. Macromolecular hydrogels

d, Pectin:

- Built by galacturonic acid monomers
- 5-10%
- The polymer *has to have* free carboxyl and esterized carboxyl groups.
- The gelling process can be fastened by adding sugar, calcium ions and acids.
- Applied in the orally used gel structure preparations.

Ointment materials

III. Macromolecular hydrogels

e, Polyacrilates, polymethacrylates:

The carbomers or poly-alcohols are acryl acid polymers with high molecular mass cross-linked with poly-alcanyl-ether.

- ***Their neutralized form with alkali, dissolves and swells in water as a colloid dispersion.***
- 1-2%
- For neutralization potassium-, sodium-, ammonium-hydroxide or triethanolamine can be used.
- The rheological behavior is influenced by the rate of neutralization.
- Less are the molecules neutralized, more elastic the created gel is.

Stability of ointments

STABILITY OF OINTMENT MATERIALS

STABILITY OF COHERENT STRUCTURES:

1. *Thermodynamic stability*
2. *Kinetic stability*

STABILITY OF OINTMENT MATERIALS

FACTORS AFFECTING THE STABILITY OF EMULSION-BASED STRUCTURE:

- temperature of melting/ softening (polymorph modifications),
- temperature difference among two phases,
- speed of cooling.

STABILITY OF OINTMENT MATERIALS

CHEMICAL CHANGES

- In case of lipogels the occurring **rancidity** is the specific chemical change.
 - Organoleptically perceptible is the color-, odor-, taste changes collectively the rancidity.
 - The materials promoting change are the degradation product of fatty acids.
- Four types: acidity,
becoming sebaceous,
ketone-rancidity,
aldehyde-rancidity.
- **Inhibition of rancidity** with two type of antioxidant :
 1. **antioxidant**, which can absorb the activated oxygen (phenol derivatives e.g.: gallic acid ethyl ester, propyl ester, tocopherol)
 2. **synergists** (two or more basic organic acids) reduces the oxidized antioxidants.

E.g.: ascorbic acid, fumaric acid, maleic acid, citric acid.

Physical changes: SYNERESIS

STABILITY OF OINTMENT MATERIALS

MICROBIOLOGICAL STABILITY

- The microbiological preservation is required in case of hydrogels and o/w type emulsions.
 - paraoxy-benzoic acid-esters 0,05-0,1%
 - chlor-butanol 0,5%
 - sorbinic acid 0,2%
 - phenyl-ethyl-alcohol 0,5-1%
 - phenyl-mercury-borate (nitrate or acetate) 0,002%.
- The concentration of preservative has to be concerned carefully because of their irritant and toxic properties.

STABILITY OF OINTMENT MATERIALS

MICROBIOLOGICAL STABILITY

Microbiological purity

Ph.Hg. VII.:

- ointments for treatment of opened wound have to be sterile.
- ointments treating skin surface are in the category of **II.** microbiological purity class, thus these has to meet with the requirements of **II.** class.

Ph.Hg. VIII.:

II. microbiological purity class.



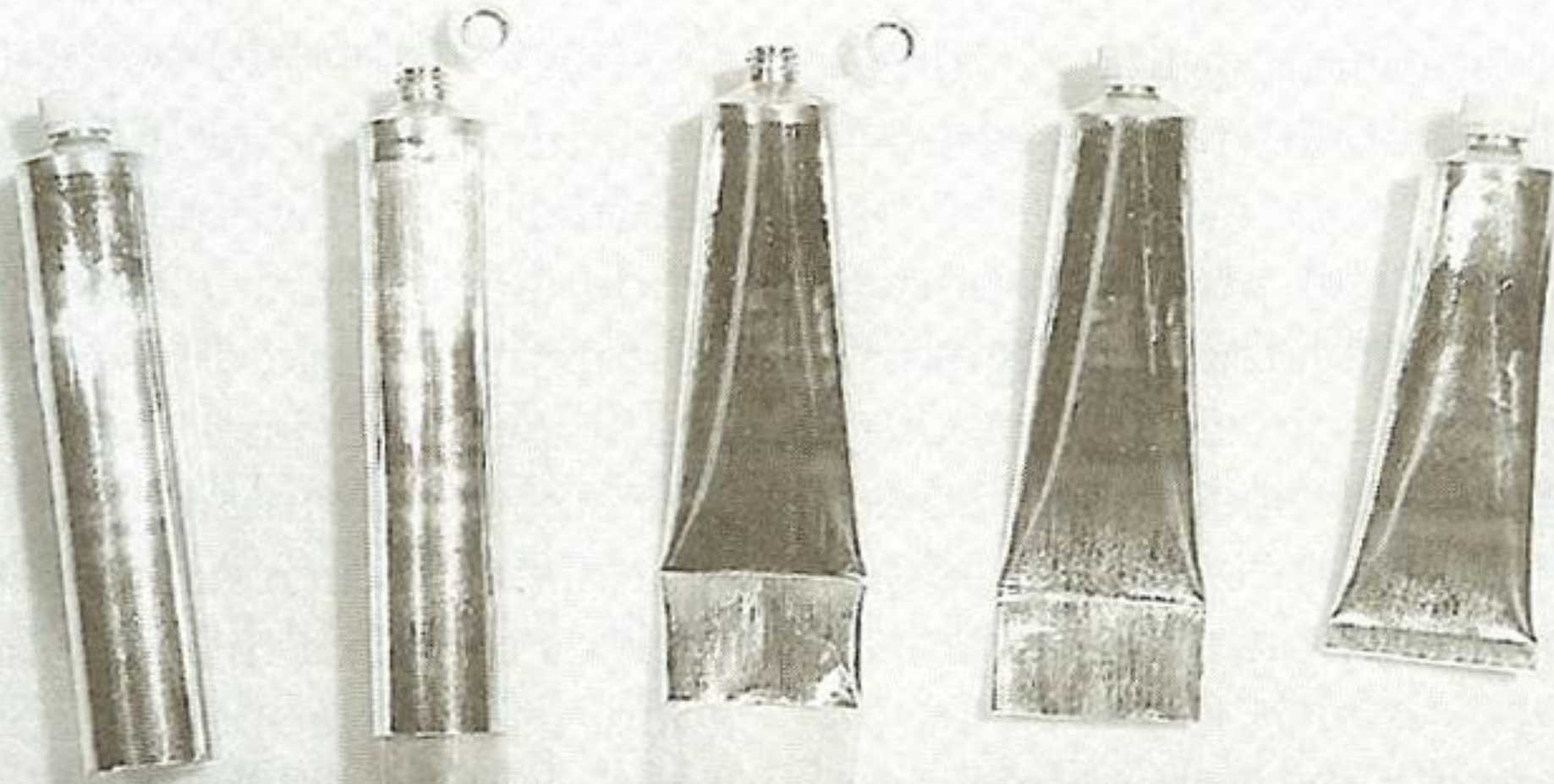

Examination of ointments, eye ointments, pastes

Institute of Pharmaceutical Technology and Biopharmacy

EXAMINATION OF OINTMENT MATERIALS

Methods for examination of gelling process, gel structure and structural stability:

1. **Examination of gelling**

(wetting, heat transfer during freezing and gelling)

2. **Morphological, energetic, transforming examination of gel structure:**

(optical, electronmicroscopic methods, rheological method, X-ray analytical examination, differential thermal analysis)

3. **Examination of structural stability**

(Observation of processes due to temperature change and storage time)

EXAMINATION OF OINTMENT MATERIALS

1. Physical examinations:

- dropping point
- freezing point
- pure melting point

2. Consistency examinations:

- Rotational rheoviscometer
- Penetrometry
- Consistometry
- Extensometry
- Spreading capability
- Adhesion
- Pressing out from tube.

3. Special examination methods:

- refers only to composition (e.g.: water absorption/ keeping, water number)

EXAMINATION OF OINTMENT MATERIALS

PHYSICAL EXAMINATION

Determination of freezing temperature:

- Zhukov's instrument (the temperature decrease can not exceed 0.2°C in every 3 seconds within 3 minutes)
- rotated thermometer method.

Dropping point examination:

- Ubbelohde instrument

Homogeneity examination:

- The ointment has to be dispersed total homogeneously, aggregated particles, nodules, liquid drops, different colored parts, strips can not be seen even with four-fold magnifying glass. (Ph.Hg.VII.)

Freezing point determination - - Ph.Eur.IV.

ZHUKOV's-instrument - Ph.Hg.VII.

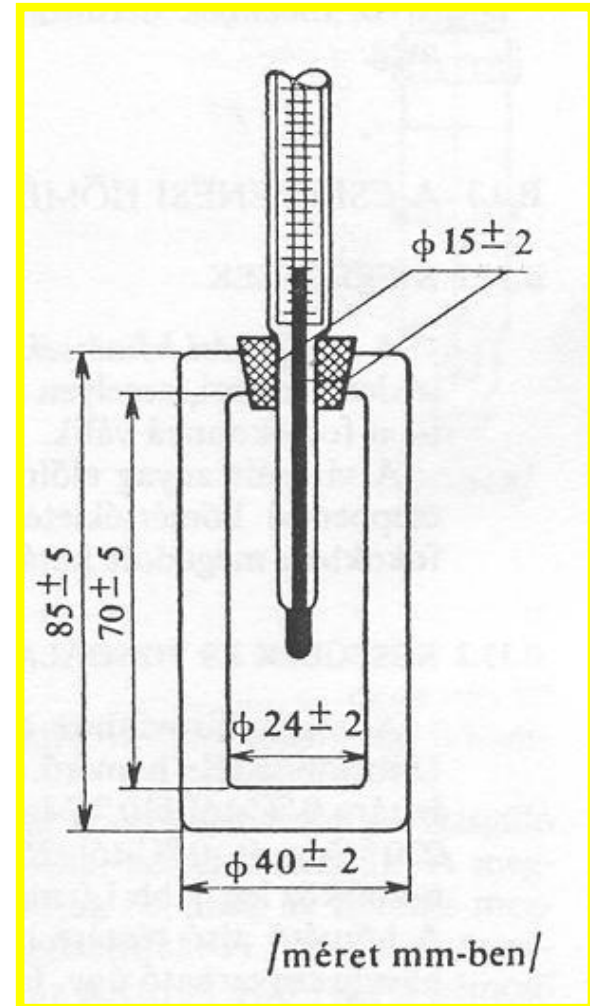
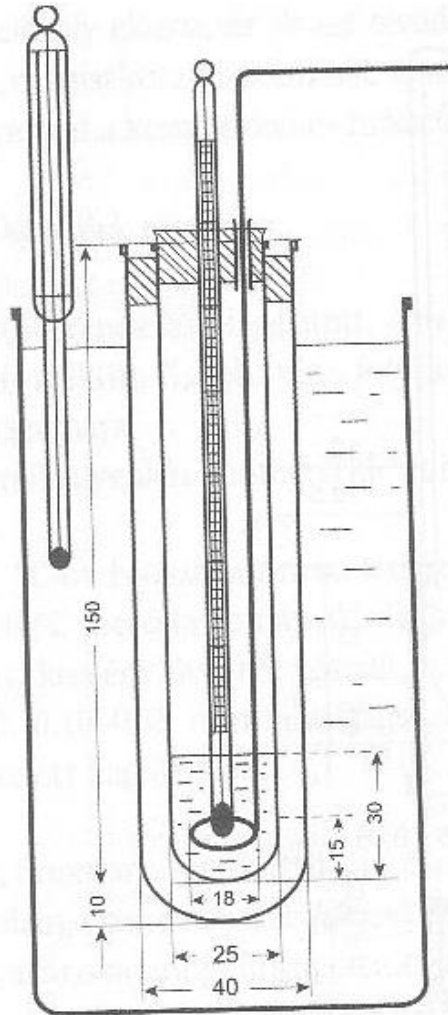

2.2.18.-1. ábra – Készülék a dermedéspont meghatározásához (méretek milliméterben)

UBBELOHDE-INSTRUMENT - Ph.Eur.IV.

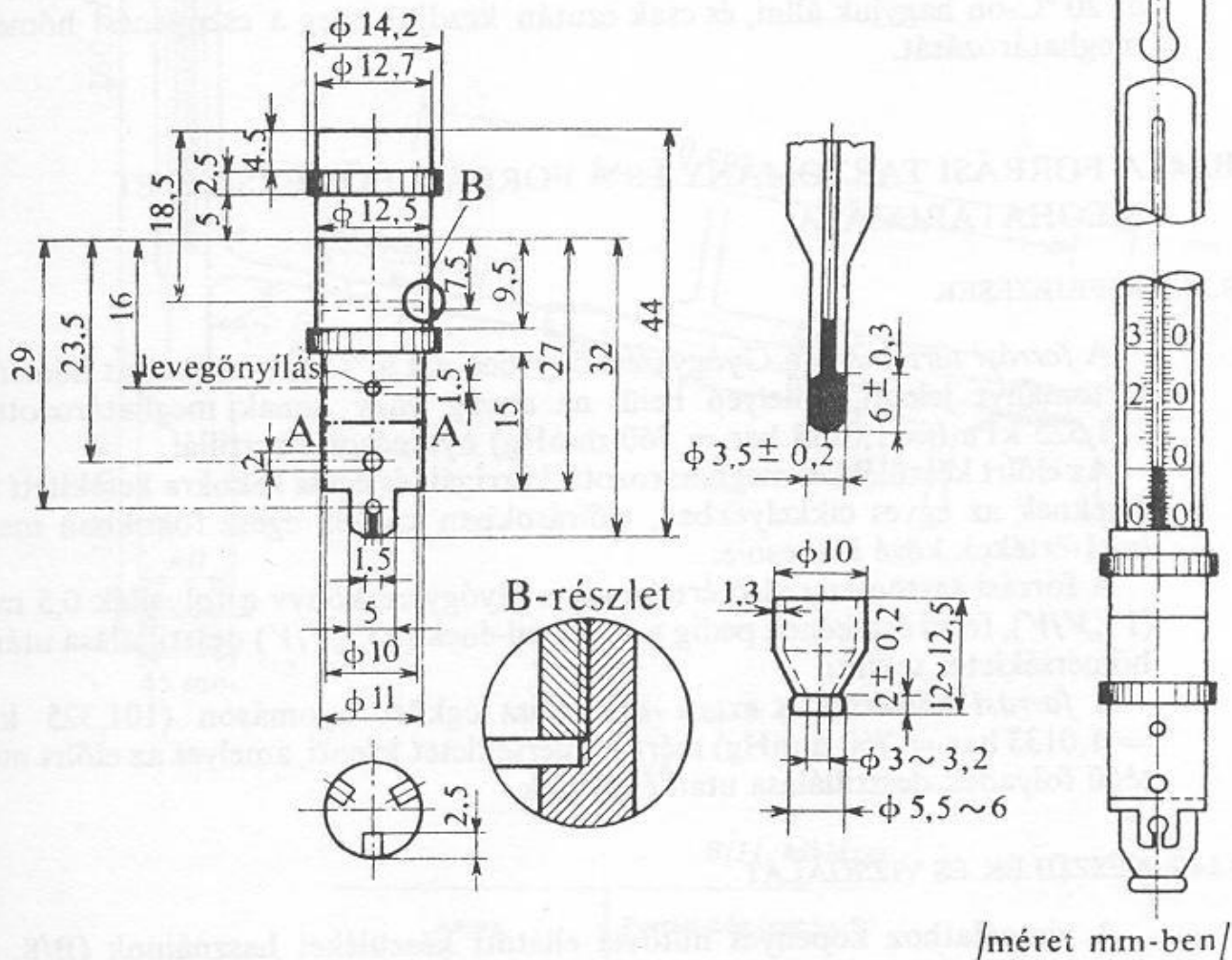

EXAMINATION OF OINTMENT MATERIALS

Consistency examinations

Consistency: the property of a structure, which resists against **mechanical forces** and this resistance can be specified quantitatively by *shearing force – deformation* function, or other rheological constant.

Aspects:

- Usage, esthetic
- Drug delivery (liberation)

Consistency determines directly the following properties:

- **Lubricity** of ointment
- Extent of the **extension** of ointment in the application area (spreading)
- **Adhesion** to the application area
- **Pressing out** from the tube

EXAMINATION OF OINTMENT MATERIALS

Consistency examinations

Methods to examine consistency:

- Rotational viscometer
- Consistometry
- Penetrometry
- Extensometry
- Examination of adhesion
- Pressing out from tube.

Consistency examinations

ROTATION VISCOMETER

- Appropriate for:
- determination of yield curves,
 - determination of structural viscosity
 - determination of thixotropy.

Operation principals:

In the ointment sample a well defined sized object (cylinder or cone shaped) rotates with constant velocity. The occurring shearing stress can be detected by transforming it to electric sign.

Consistency examinations

ROTATION VISCOMETER



Consistency examinations

ROTATION VISCOMETER

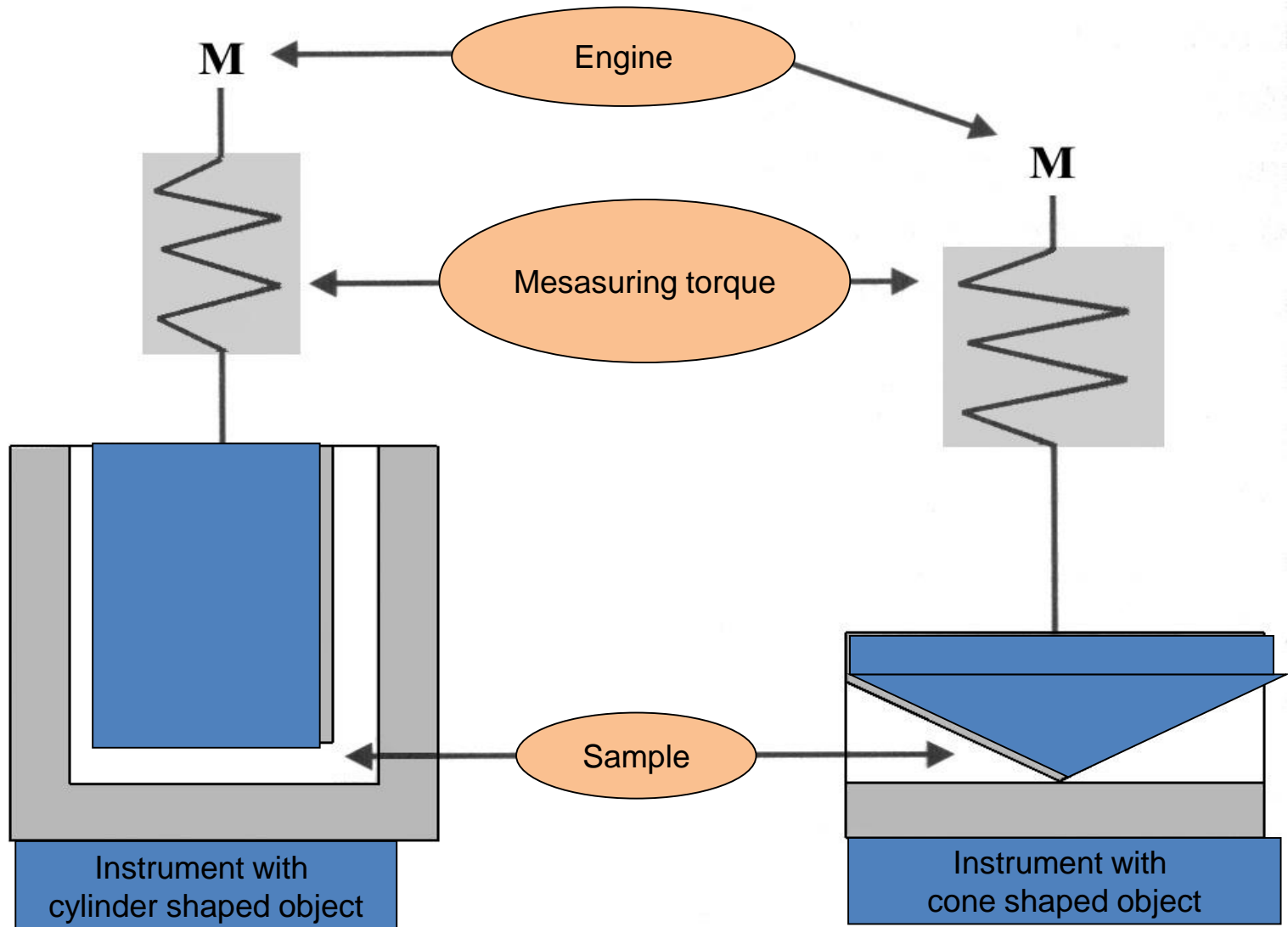

Rotációs viszkoziméterek vázrajza

Consistency examinations

ROTATION VISCOMETER

Thixotropic regeneration

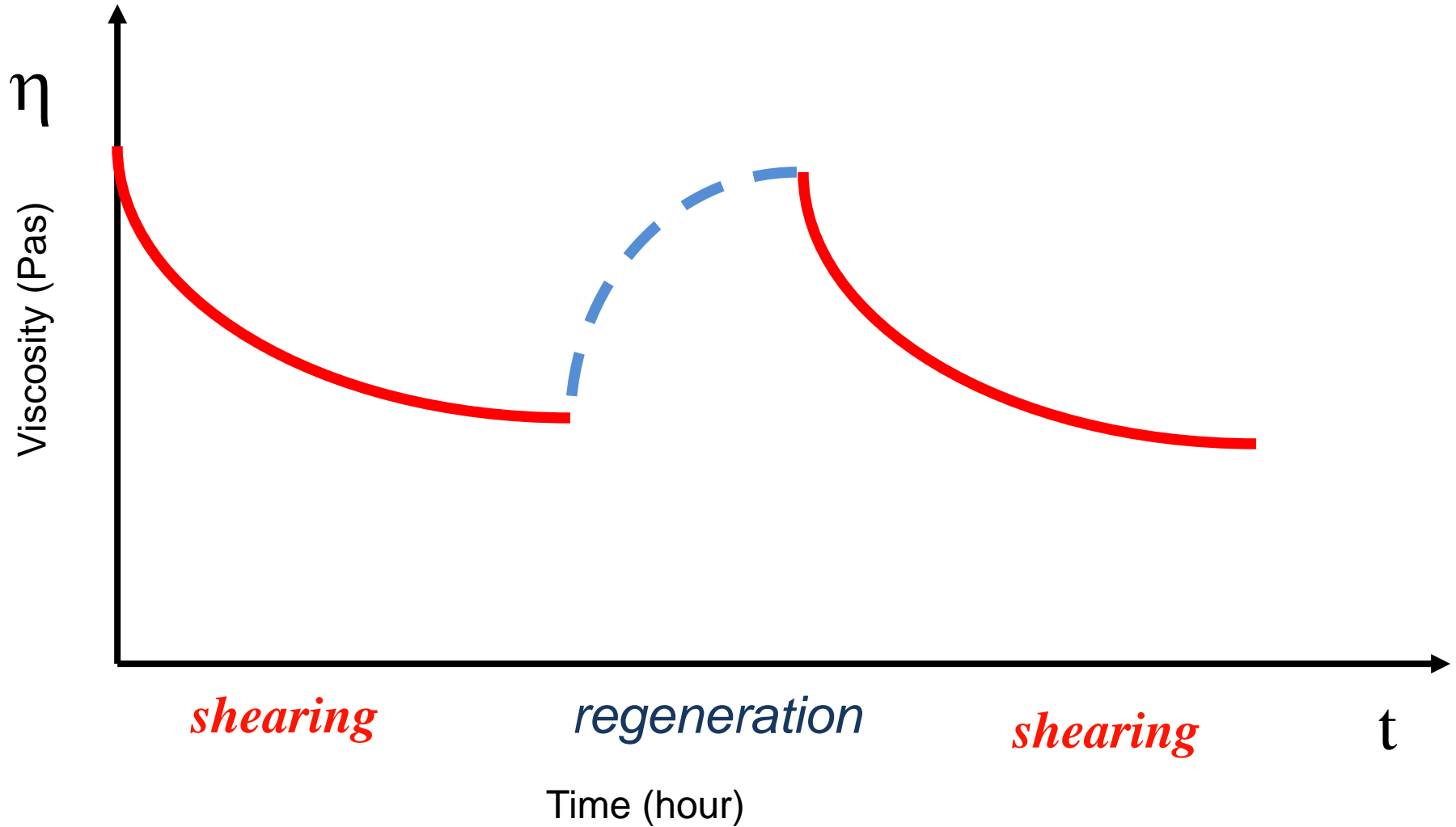

Consistency examinations

CONSISTOMETRY

A well defined object (cone or ball-shaped) immerses into the sample ointment in changeable affecting force. The penetrating velocity can be expressed numerically, quantitatively.

Appropriate for: determination of viscosity, dilatant, reopexy properties having materials.

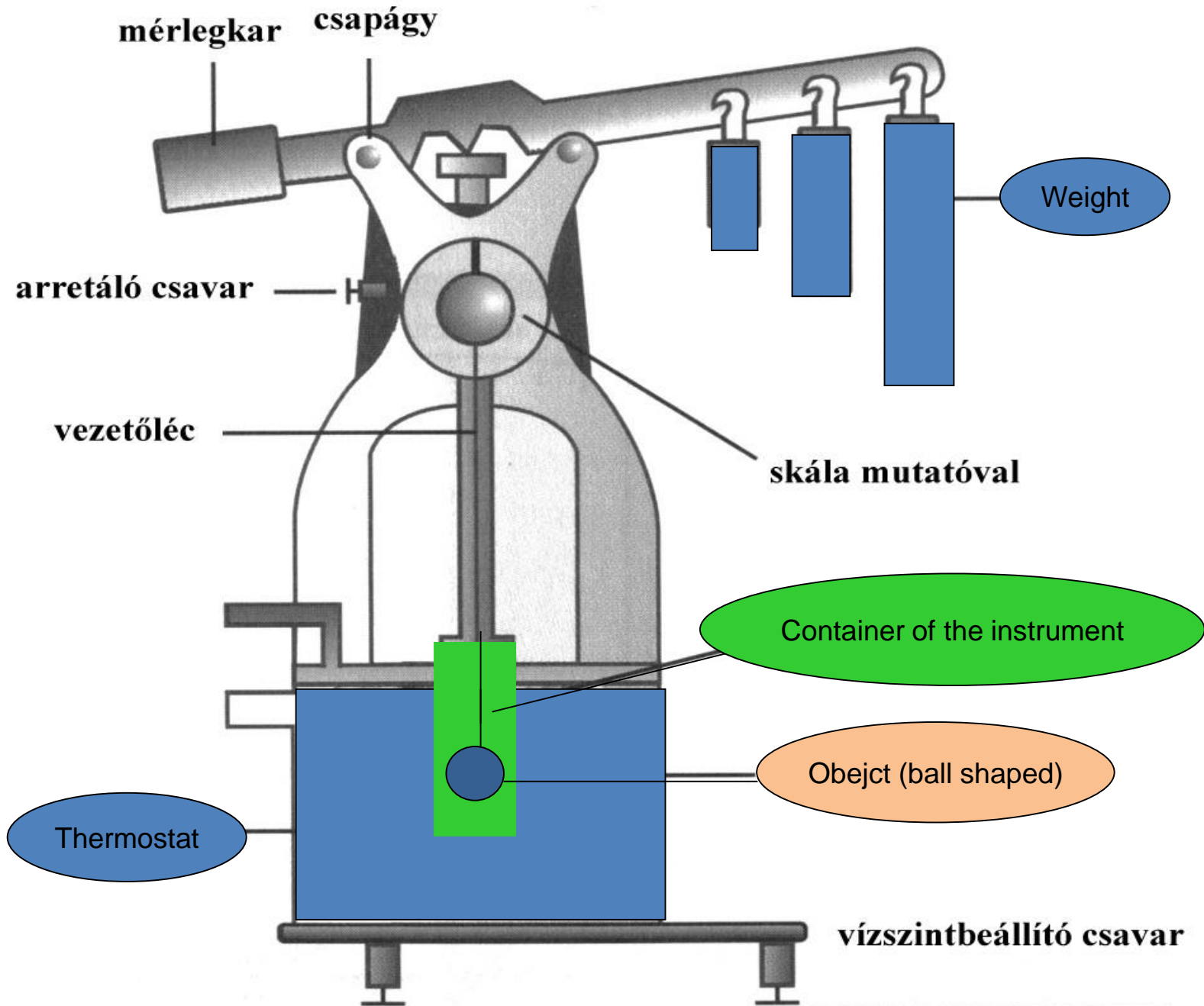

Structure of the consistometer

Consistency examinations

PENETROMETRY

An object with standard size penetrates into the ointment sample

(doubled cone, needle, cone).

Penetration unit is the „penetration degree” (° P).

The penetrometry examination is device for consistometric measuring, which is official in Ph.Hg. VII./VIII. and Ph.Eur. IV.

Penetrometry

$$r = h * \operatorname{tg} \frac{\alpha}{2}$$

$$A = r^2 \pi$$

$$ha$$

$$\alpha = 90^\circ$$

$$r = h$$

$$\operatorname{tg} \frac{\alpha}{2} = 1$$

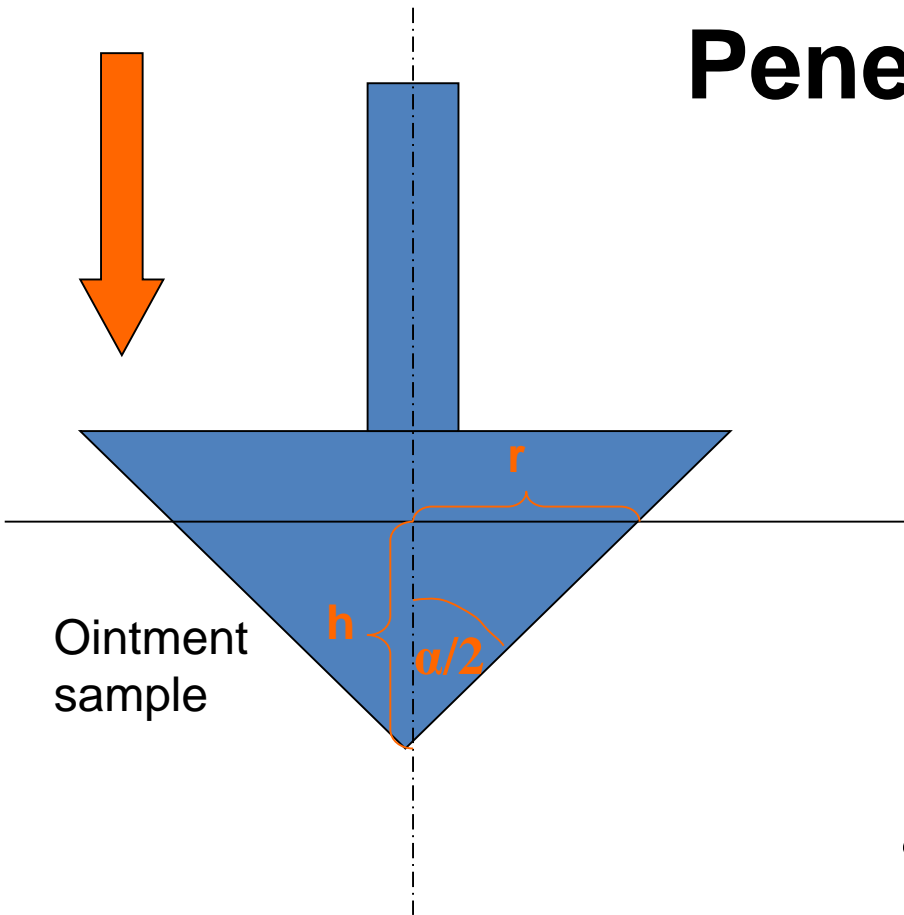

$$A = h^2 \pi$$

$$V = \frac{r^2 \pi h}{3}$$

α = angle of cone peak

A = area of the penetrated part of cone

r = radius of cone in the level of penetration

V = volume of the penetrated part of cone
(volume of the ointment forced out)

Penetrometry - Ph.Hg.VIII.

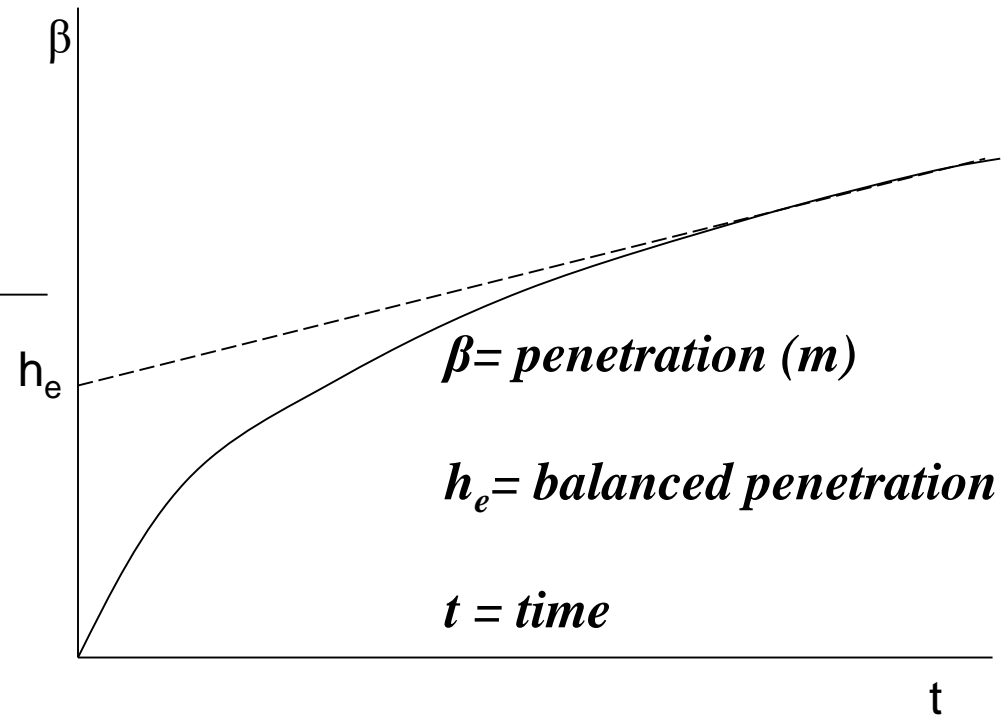
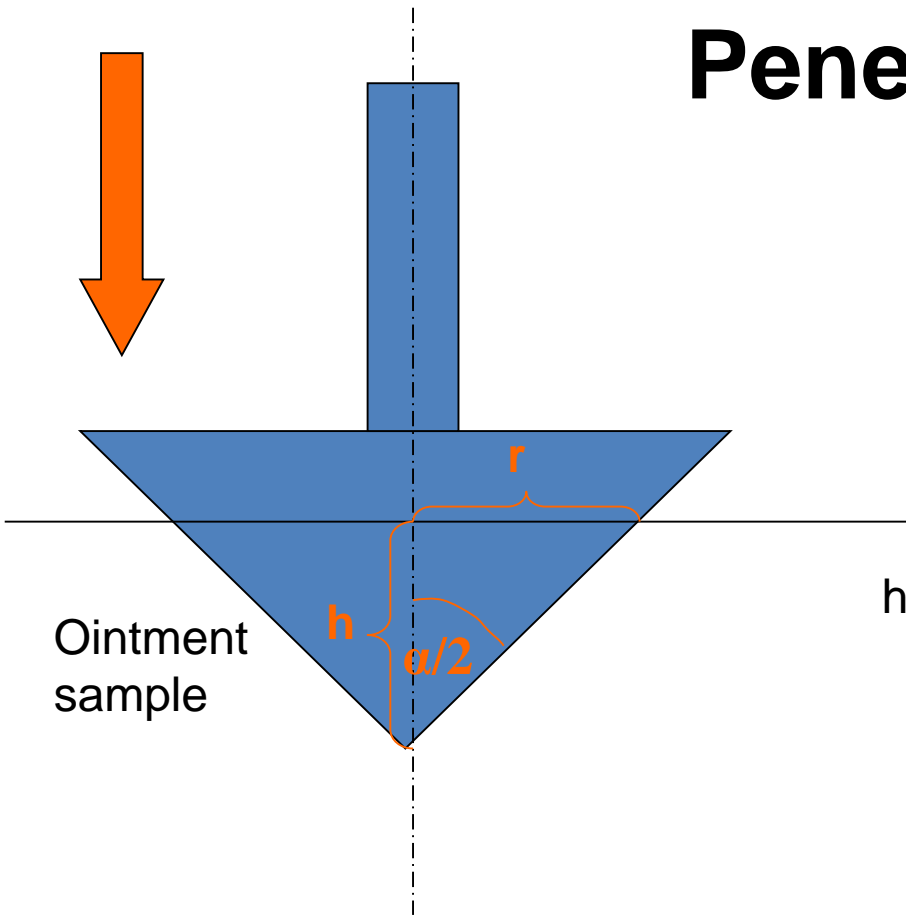

Rebinder equation

$$\sigma = k \frac{mg}{h^2}$$

$\sigma = \text{limit value of pressure}$

$m = \text{mass of cone}$

$k = \text{constant}$

$g = \text{gravitational acceleration}$

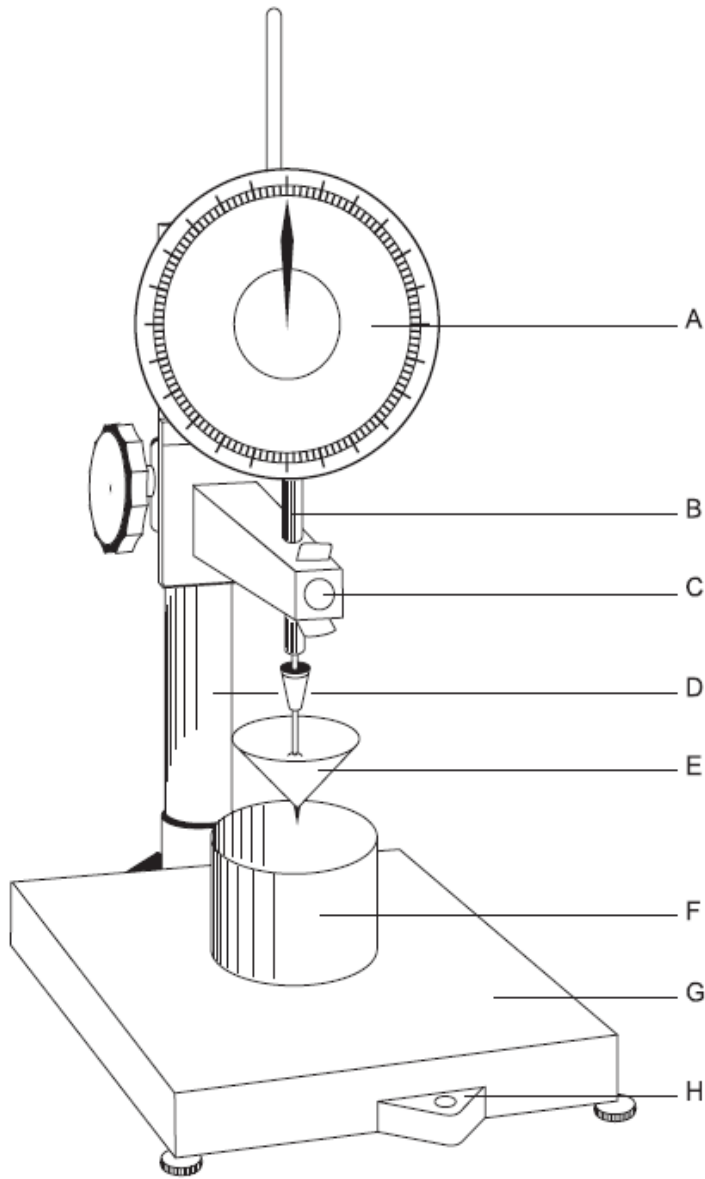

A. Scale showing the depth of penetration, graduated in tenths of millimeters.

B. Vertical shaft to maintain and guide the penetrating object.

C. Device to retain and to release the penetrating object automatically and for a constant time.

D. Device to ensure that the penetrating object is vertical and that the base is horizontal.

E. Penetrating object.

F. Container.

G. Horizontal base.

H. Control for the horizontal base.



Consistency examinations

Examination of extension

OPERATION OF EXTENSOMETER:

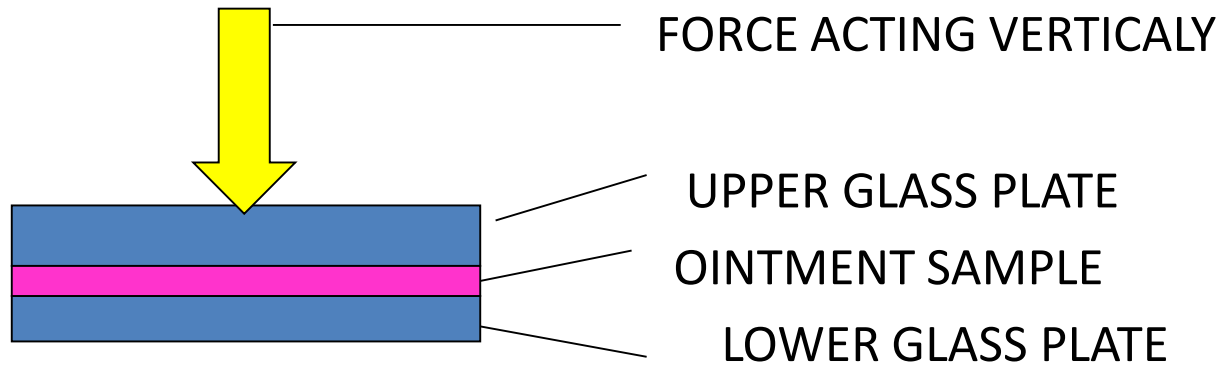

t_1

Consistency examinations

PRESSING OUT FROM TUBE

This examination determines how much force is needed to press out a defined amount of ointment from the tube, in particular examination circumstances.

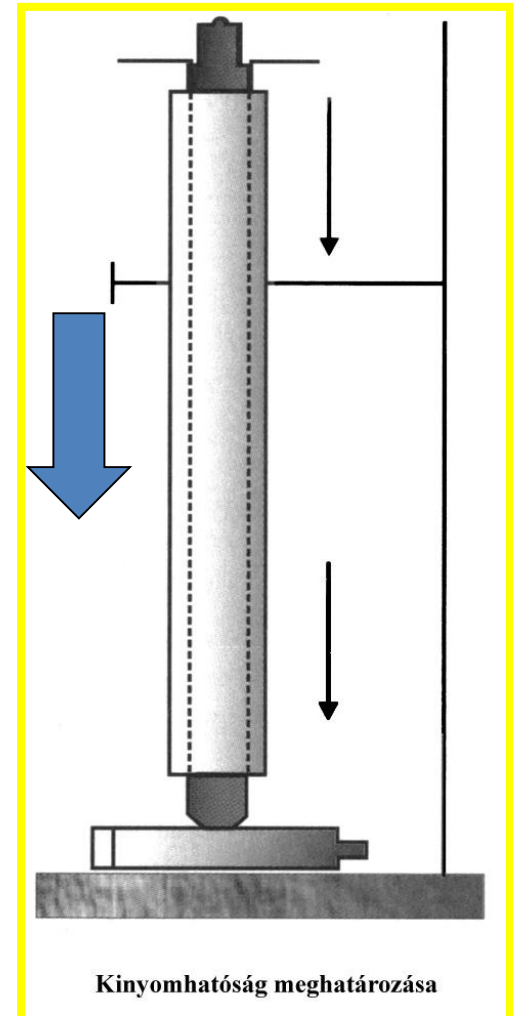

Consistency examinations

EXAMINATION OF ADHESION

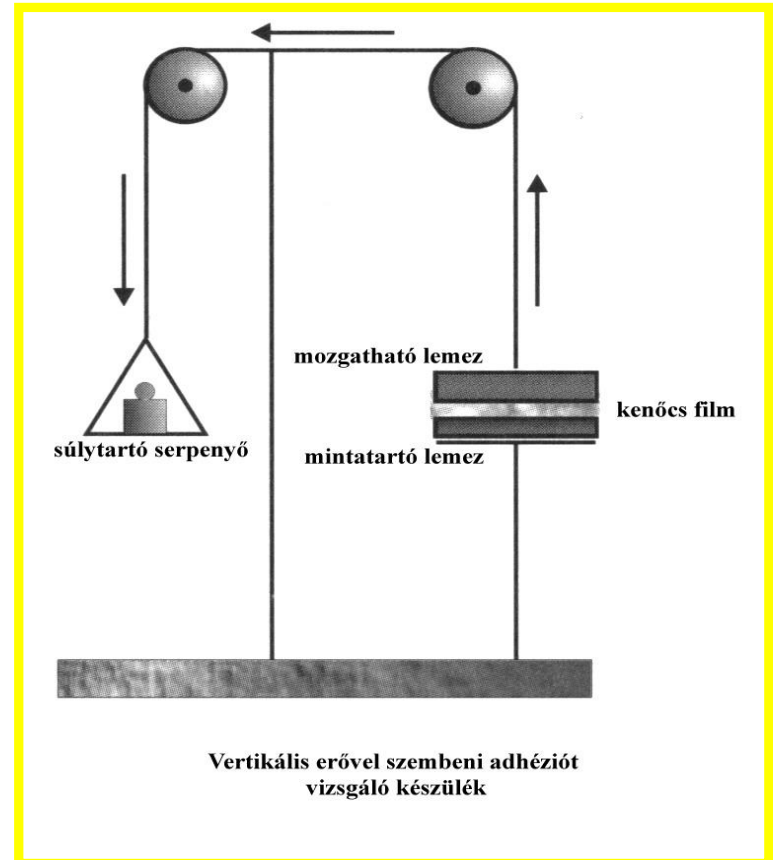
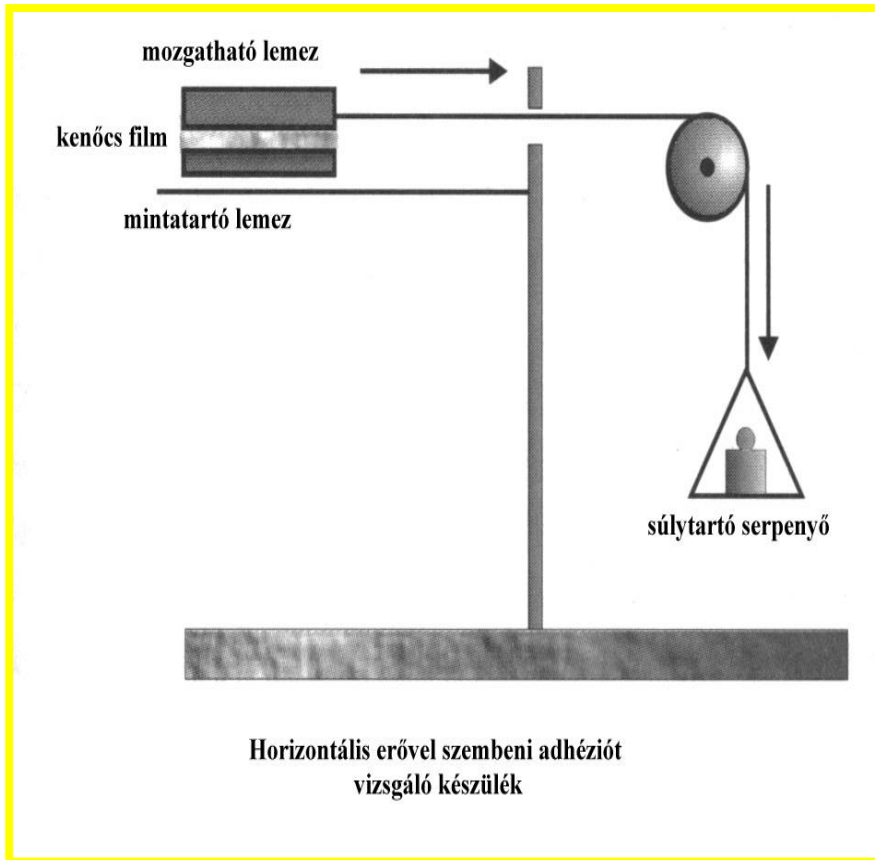

Pendulum equipped with sliding thread. The passed time is measured from the beginning of swinging to stopping.

WATER ABSORBING CAPABILITY

$$v_f = \frac{b-a}{b} \cdot 100,$$

where: v_f = water absorbing capability in %,
 a = mass of sample in grams,
 b = the total mass of original ointment sample and the emulsified water in grams .

Determined by the quality and quantity of emulsifying agent.

In the case of lipophilic ointment materials the water number is more important parameter than the water absorbing capability.

The **water number** expresses the highest water content in grams, which is kept by ointment in room temperature after 24 hours.

Determination method of water number:

In the tared patendula with pestle 25,0 g water-free ointment sample is melted, and partly water is added in an appropriate temperature, in a 110% quantity of the expected water absorption. The ointment has to be cooled down, and we let it in room temperature until 24 hours. Then the separated water has to be moped with filter paper. The ointment has to be homogenized again and measured back.

Lipophilic ointment materials – **water number is more important than water-binding property.** (The correlation between water-absorbing capability and water number is not linear, even the water number is mostly less than the water absorbing capability.)

Water number

The water amount, which is kept by 100g of water-free ointment material after intensive mechanical stress.

$$\text{water number} = \frac{100 m_a}{m_b}$$

where: m_a = *mass of absorbed water by ointment*

m_b = *mass of examined material in grams.*

Eye ointments, pastes, light-protective preparations

Institute of Pharmaceutical Technology and Biopharmacy

EYE OINTMENTS

Semisolid ophthalmic preparations (Ph.Hg.VIII.)

Semi-solid eye preparations are **sterile** ointments, creams or gels intended for **application to the conjunctiva**. They contain one or more active substances dissolved or dispersed in a suitable basis. They have a homogeneous appearance.

The basis is non-irritant to the conjunctiva.

Semi-solid eye preparations are packed in small, sterilized collapsible tubes fitted or provided with a cannula and having a content of **not more than 5 g of the preparation**

FoNo VII. 10 g

EYE OINTMENTS

STORAGE: - in cool place at most 20 °C

The expiry date has to be noted when giving to patient.

EXAMINATION:

a., **particle size** : in case of manufactured preparation linear size of 80% of dispersed particle at most 5-10 μm.

The linear size of 20 % of particles is 20-30 μm .

In case of magistral preparations particle size are in 25-50 μm.

b., microbiological purity

c., consistency examination: penetrometry, yield point.

In Ph.Eur. IV.: ointment is examined equivalent to min. 10 μg solid active substance in thin layer on glass slide.

Microscopic examination: max. 20 > 25 μm,
max. 2 > 50 μm,
∅ > 90 μm.

Light protective preparations

Light-protective preparations

Effect of light

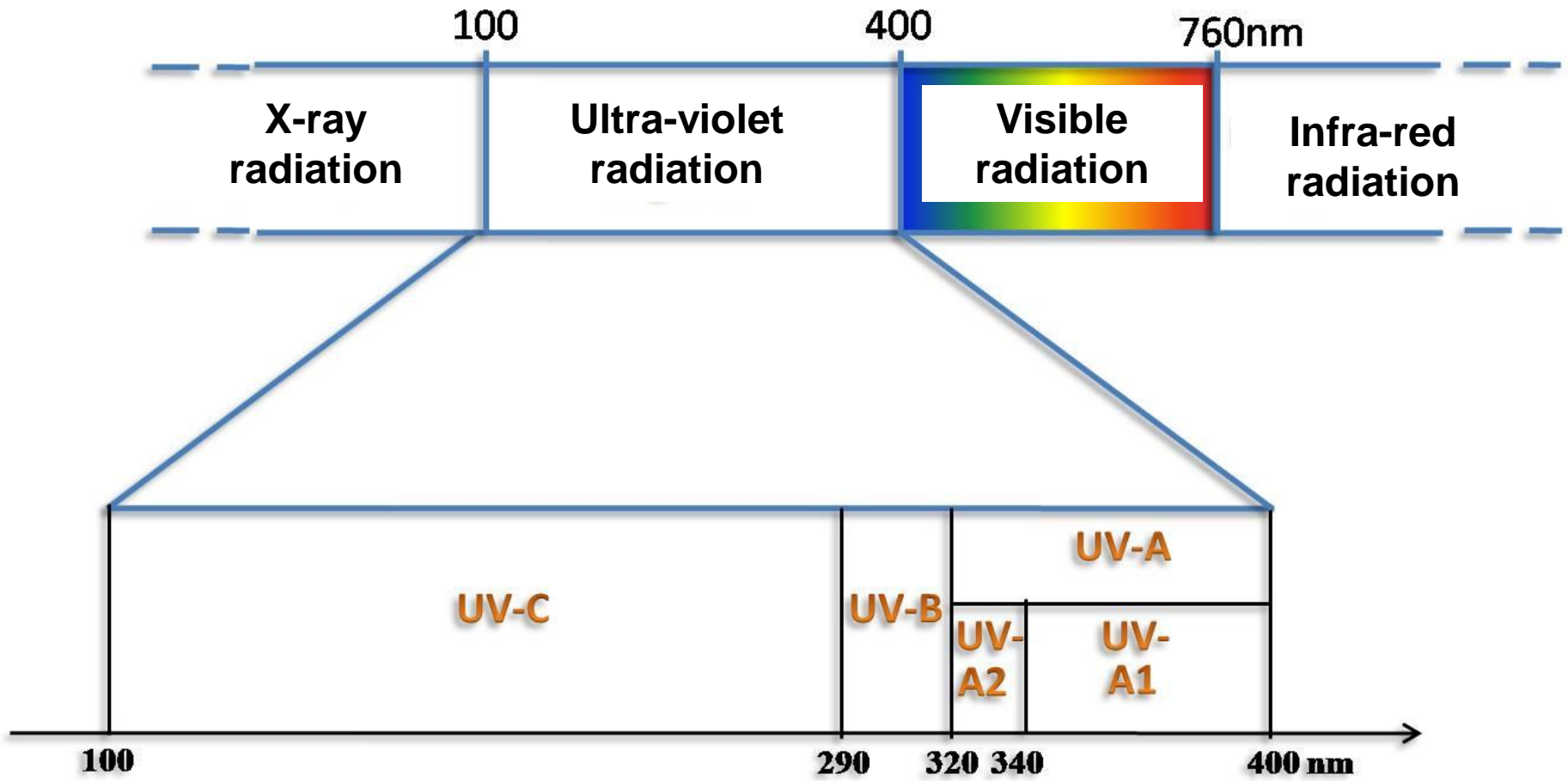

The effects of sunlight on eyes and skin

Radiation	Skin	Eye
UV-C	Redness of skin (erythema), skin cancer, acceleration of aging of skin	Inflammation of cornea caused by light (fotokeratitis)
UV-B	Increased pigmentation	Inflammation of cornea caused by light (fotokeratitis)
UV-A	Pigments turn darker burned skin	Cataracta developed by photochemical way
Visible	Pigments turn darker burned skin Photosensible reaction	Retina injury caused by heat and photochemical way

UV-A radiation

Assist to aging the skin by effect on deeper layers of skin

Assist to develop skin cancer.

Our skin reacts for UV -A radiation with turning brown, which is created by the melanin synthesis stimulated by light radiation.

This radiation induce the production of vitamin D.

The range of UV-A can be divided into two sections:

Higher waves than 340 nm (UV-A1)

And lower waves than 340 nm (UV-A2) .

UV-B

Radiation, **UV-B** make skin tanned brown, and help:

- Production of vitamin D,
- Skin inflammation („burning”)
- Redness of skin(*erythema*),

-DNA damage and melanoma.

- Due to the high energy waves, getting into skin layers, DNA spirals are damaged directly ,
- change in genetic of skin,
- This can be the base of further developing skin cancer.

The UV-B waves interact with the elastic and collagen fibers of connective tissue, and cause aging.

Sun Protection Factor (*SPF*)

The Sun Protection Factor, SPF specifies the protection against UVB radiation of light-protective preparation.

If the preparation is used properly, then preparation with 15-25 light protective factors provides appropriate protection for normal skin against burning (SPF = 93-98%).

Preparations with higher factors are only necessary, if the preparation is applied in lower amount or on more sensitive skin type.

Light-protective preparations

Modern light-protective materials

Their effect can be expressed by:

- Active/chemical way
- Passive/physical way.

The active light protective materials can even absorb and transform UV-light, which is severe for the skin.

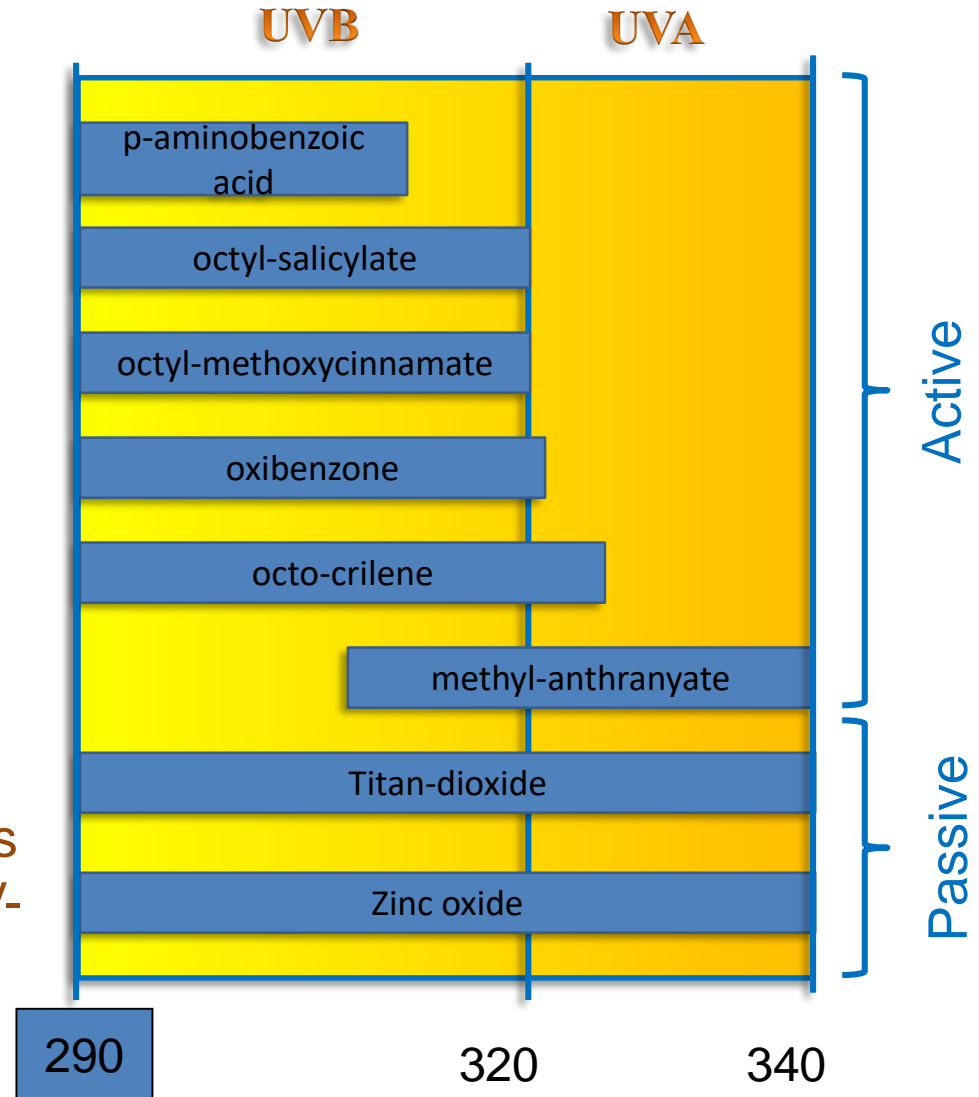

absorption spektrum of UV-A, UV-B

Modern light-protective materials

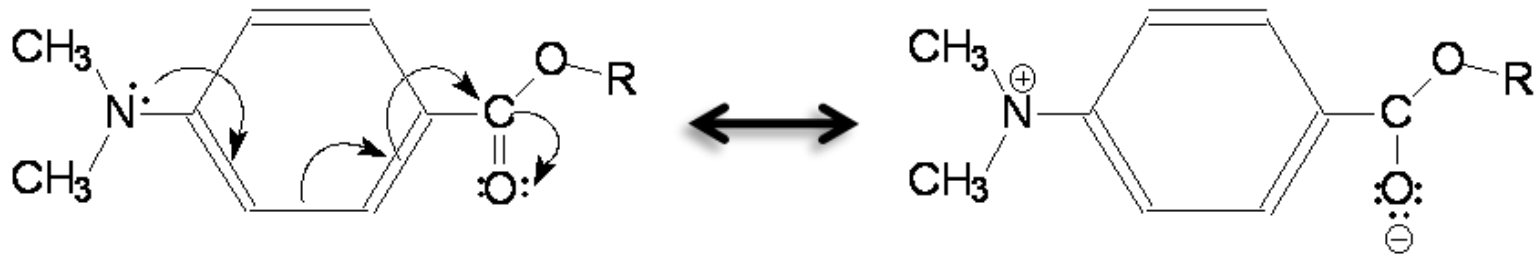

Ground state

Excited state

Internal rearrangement of N,N-dimethyl para-amino benzoic acid molecule after affected UV light.

Modern passive light-protective materials

The passive, physical protective molecules act by their **reflection** and **scattering effect**.

The penetration of light is inhibited in wide spectrum by covered skin surface, the damaging waves practically can not get through their layer.

Most frequently used inorganic substances are *titan-dioxide* and *zinc-oxide*.

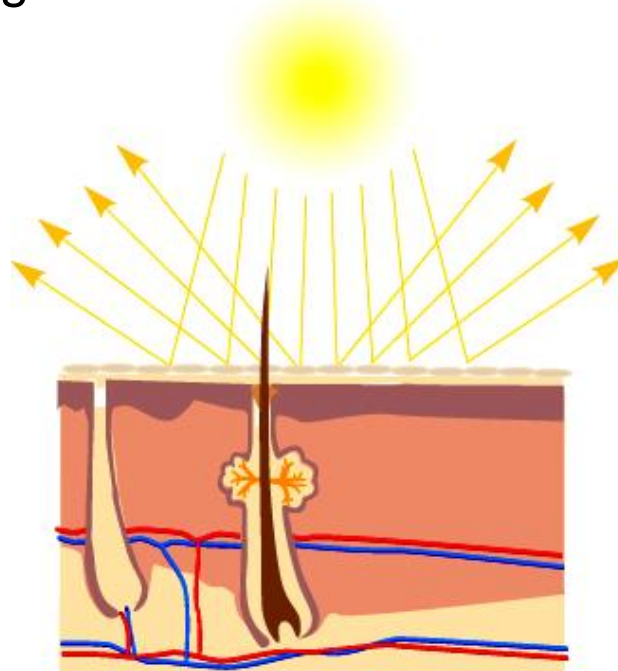

Modern passive light-protective materials

Nanonized zinc-oxide (d 50nm) are much more effective than micronized. Smaller particles can create easier a barrier providing better protection

micronized

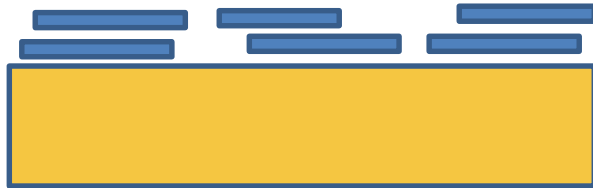

nanonized

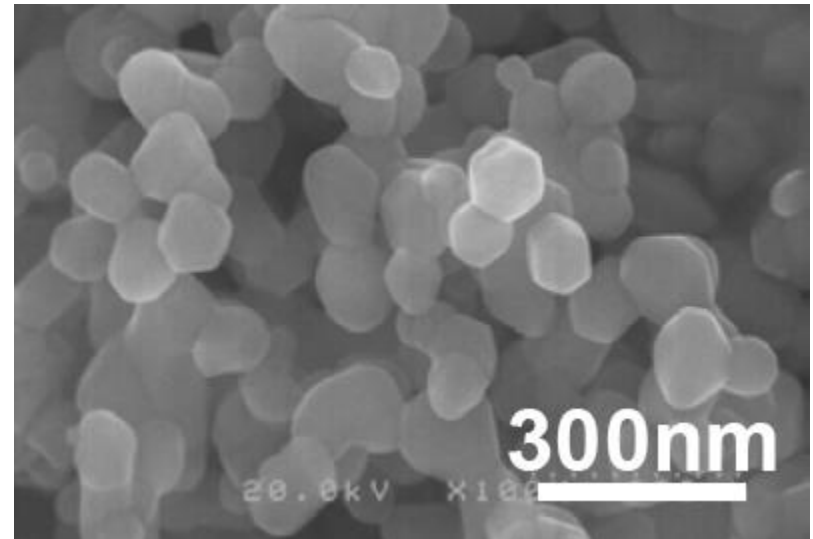

Thank you for attention!