

Examination of granules

Institute of Pharmaceutical Technology and Biopharmacy
University of Pécs

Investigation of powders

- X-ray powder diffraction,
- thermal analysis,
- microcalorimetry,
- calorimetry,
- liquid calorimetry,
- NIR spectroscopy,
- spectroscopy
- absorption and Raman spectroscopy,
- solid state NMR,
- optical microscopy.

Physical examinations

Institute of Pharmaceutical Technology and Biopharmacy
University of Pécs

Weight uniformity

Uniformity of mass of single-dose preparations

Average mass of powder

Weigh individually **20** units taken at random or, for single-dose preparations presented in individual containers, the contents of 20 units, and determine the average mass.

Not more than 2 of the individual masses deviate from the average mass by more than the percentage deviation shown in Table and none deviates by more than twice that percentage.



Pharmaceutical Form	Average Mass	Percentage deviation
Capsules, granules (uncoated, single-dose)	Less than 300 mg	10
and powders (single-dose)	300 mg or more	7.5

Particle shape

Particle shape (sphericity)

Shape factor (α)

$$\alpha = \frac{D_{min}}{D_{max}}$$

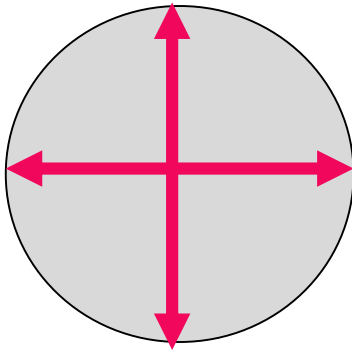

Ideal

$$\alpha = 1$$

$$D_{min} = D_{max}$$

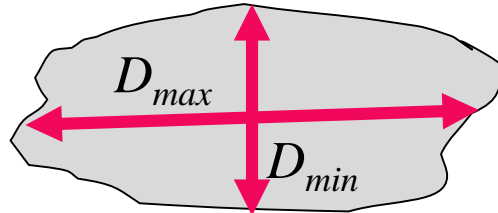

Real 1.

$$\alpha \leq 1$$

$$D_{min} < D_{max}$$

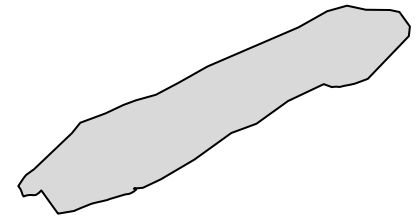

Real 2.

(inappropriate technology)

$$\alpha \ll 1$$

$$D_{min} \ll D_{max}$$

The issue later in

Particle size

Particle size:

- Mean particle size = average size of linear diameter
- Statistical diameter = length of a section in the direction of the measurement
- Equivalent circular diameter = diameter of a circle with the same projection surface
- Equivalent spherical diameter = diameter of a sphere with the same volume

Particle size

Methods for the measurement of particle size:

- Optical analysis (microscopy)
- Sedimentation techniques
- Electrical sensing
- Laser light based methods
- Sieve analysis

Particle size distribution

Examination is carried out by sieve analysis

fine powder: 25 -50 gramme,
coarse powder: 100 gramme

sieving device: 200 oscillations for 5-10 mins
amplitude: 0.5-0.8 mm



Particle size

Particle size - average particle size (\bar{d})

$$\bar{d} = \frac{\sum x_i y_i}{\sum y_i}$$

x_i particle size
 y_i frequency

Particle size

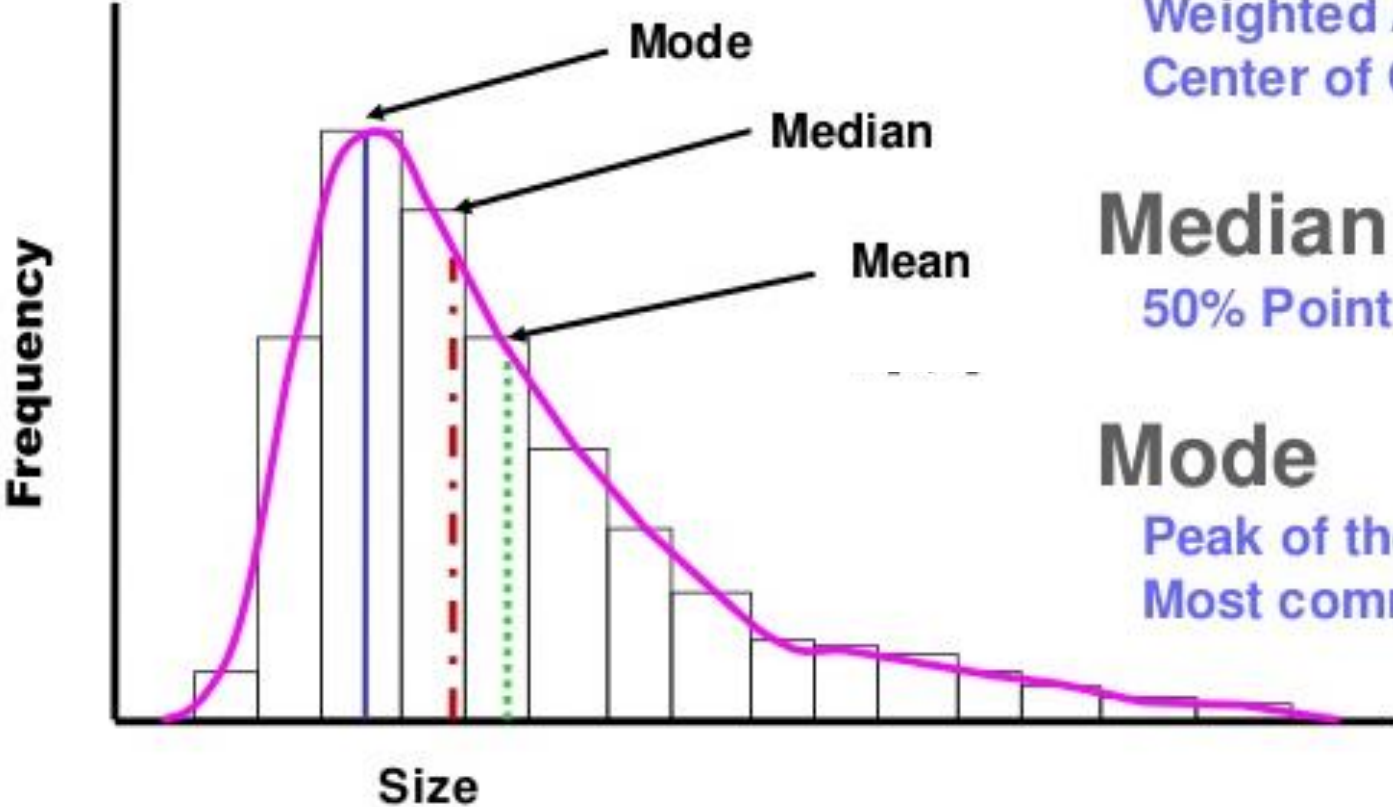

Mean

Weighted Average
Center of Gravity

Median

50% Point

Mode

Peak of the distribution
Most common value

Particle size

MN 104 Example
Grain Size Distribution

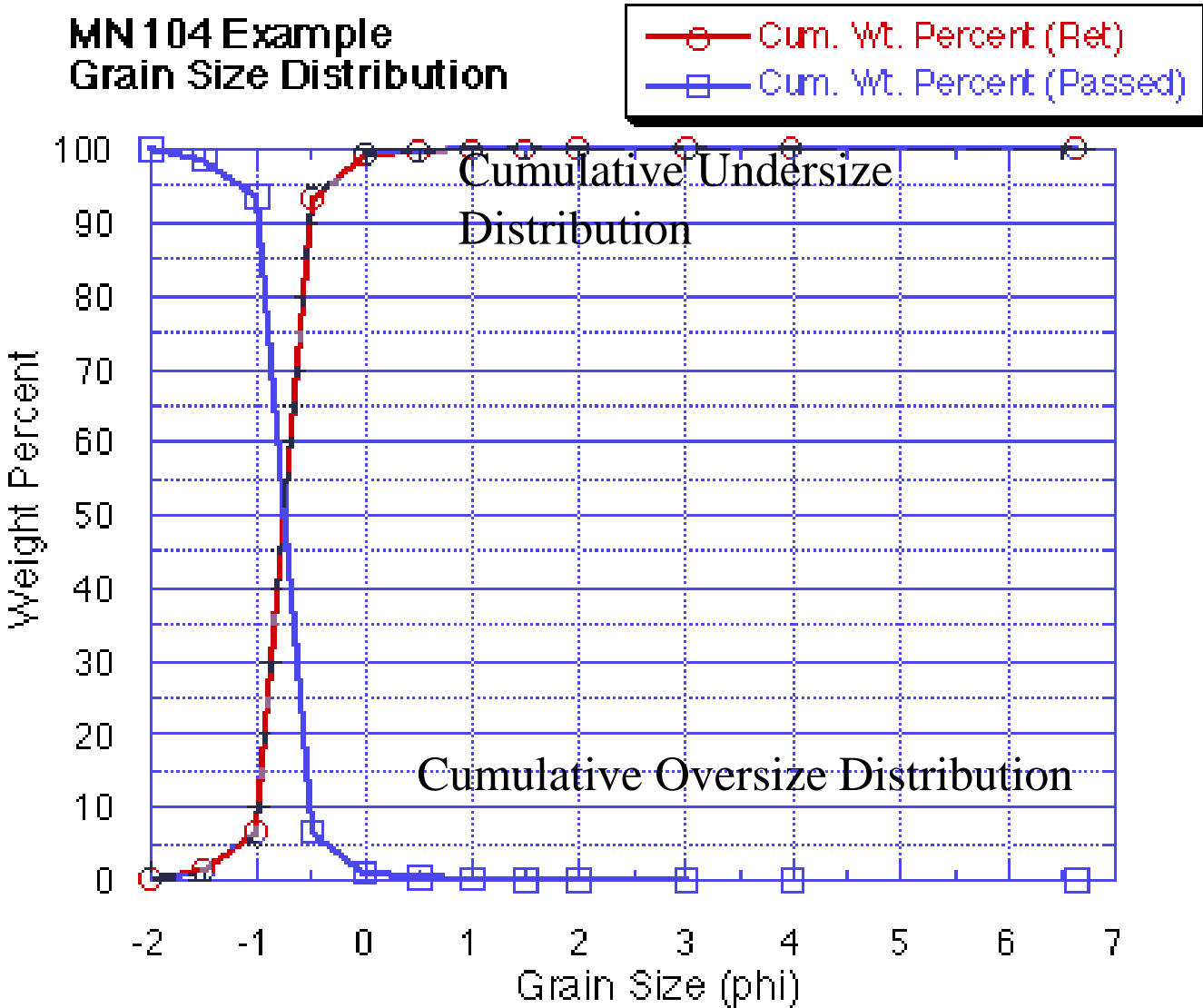

Particle size

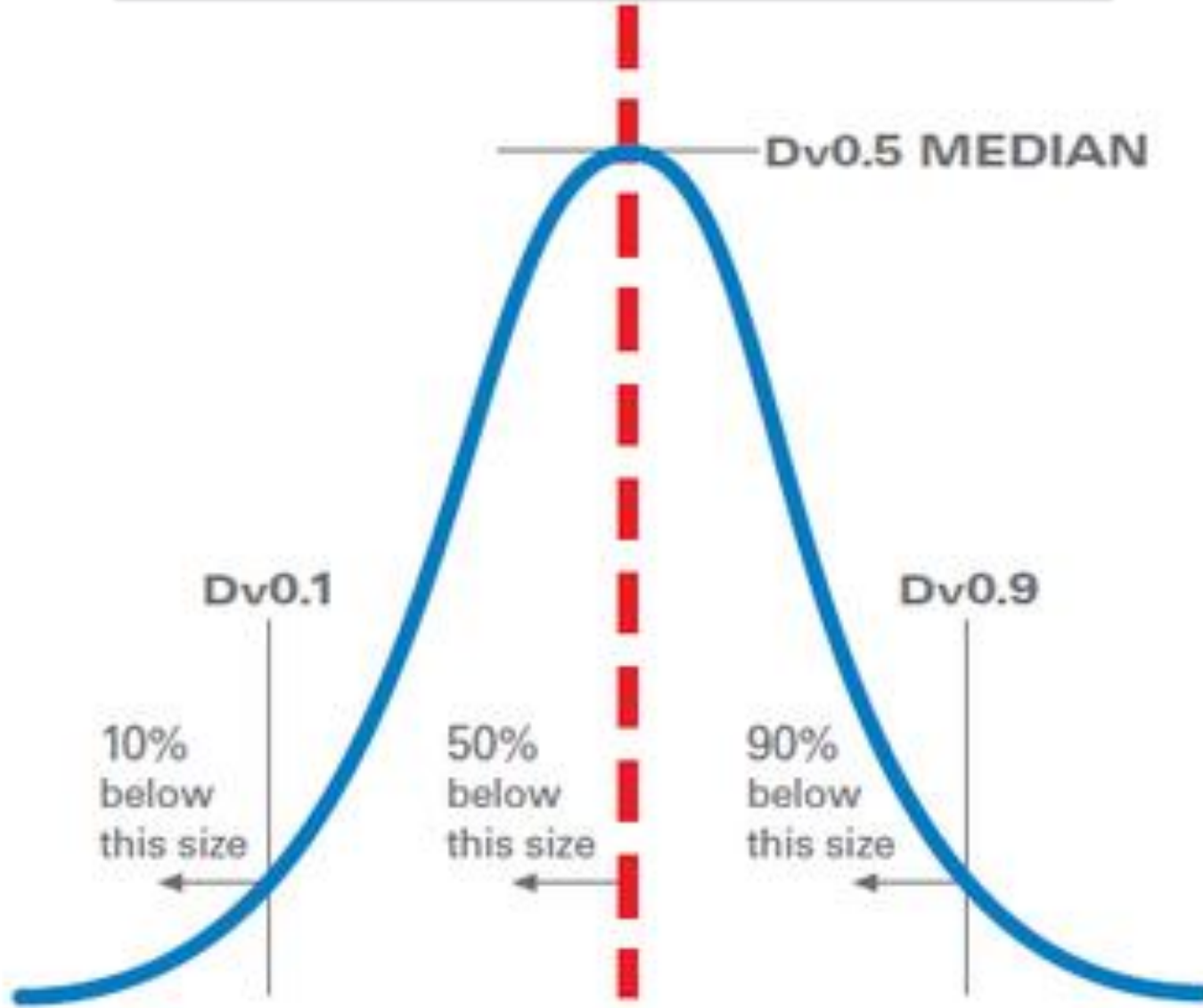

Particle size

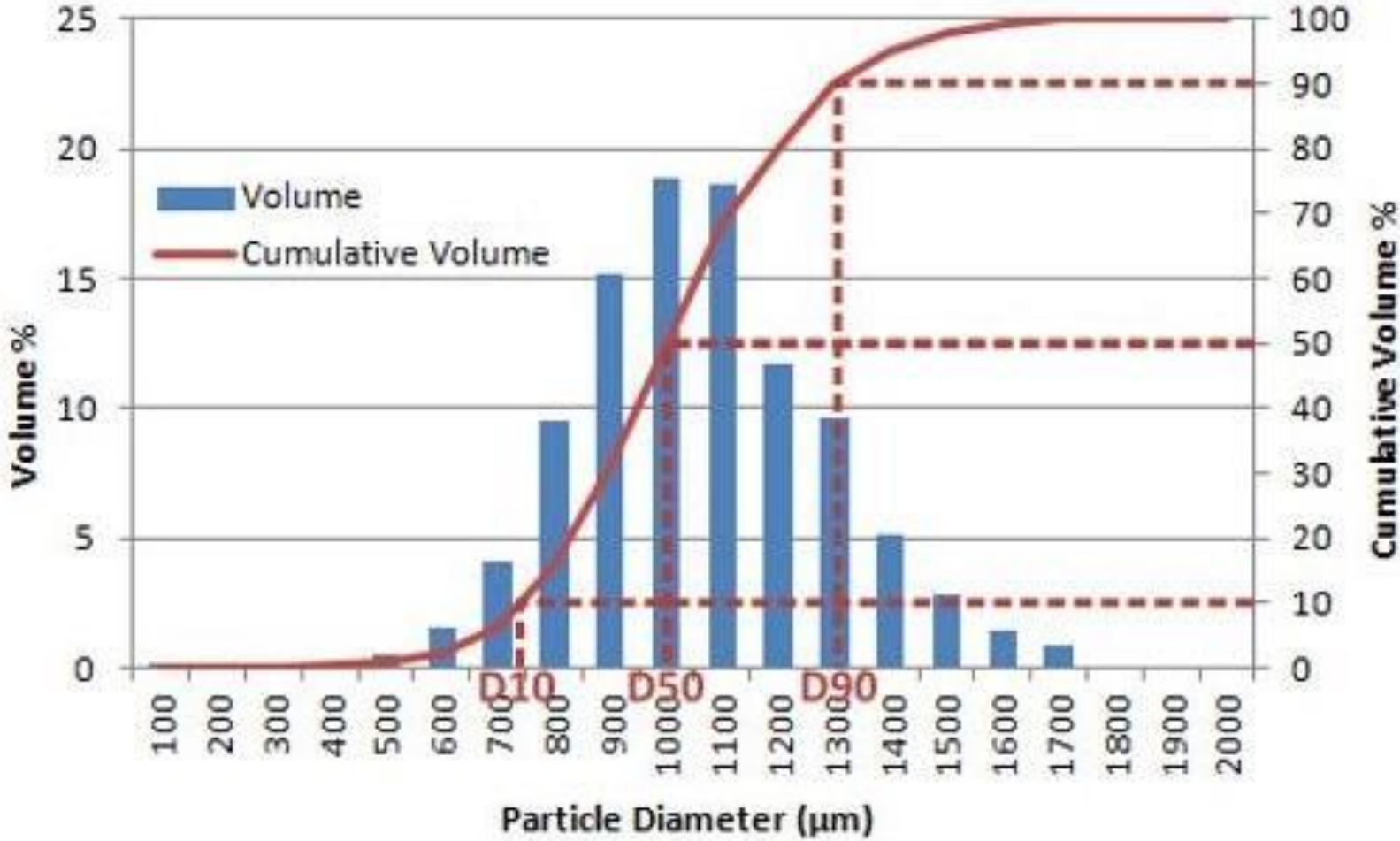

Particle size

The following terms are used in the description of powders:

Coarse powder. Not less than 95 per cent by mass passes through a number 1400 sieve and not more than 40 per cent by mass passes through a number 355 sieve.

Moderately fine powder. Not less than 95 per cent by mass passes through a number 355 sieve and not more than 40 per cent by mass passes through a number 180 sieve.

Fine powder. Not less than 95 per cent by mass passes through a number 180 sieve and not more than 40 per cent by mass passes through a number 125 sieve.

Very fine powder. Not less than 95 per cent by mass passes through a number 125 sieve and not more than 40 per cent by mass passes through a number 90 sieve.

Particle surface

Surface

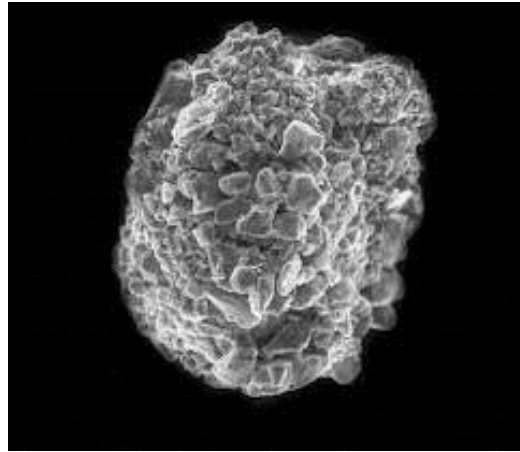

granule

surface

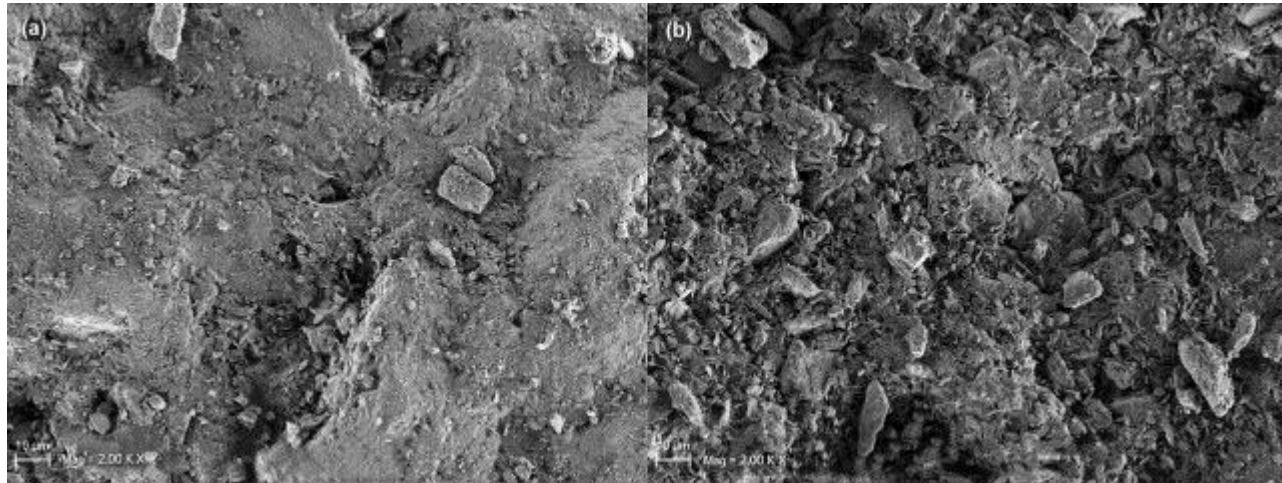

Particle surface

Structure

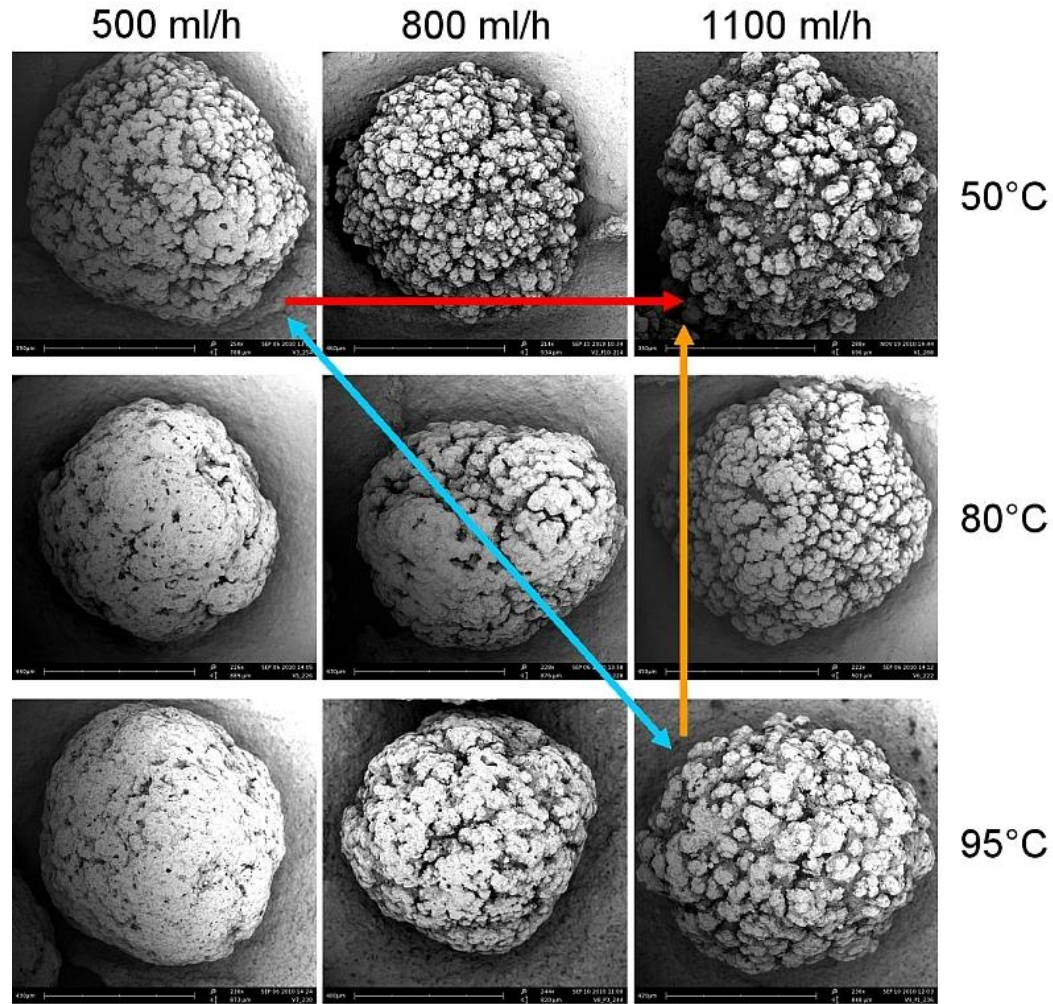

Particle structure at different spray rates and air temperatures

Density

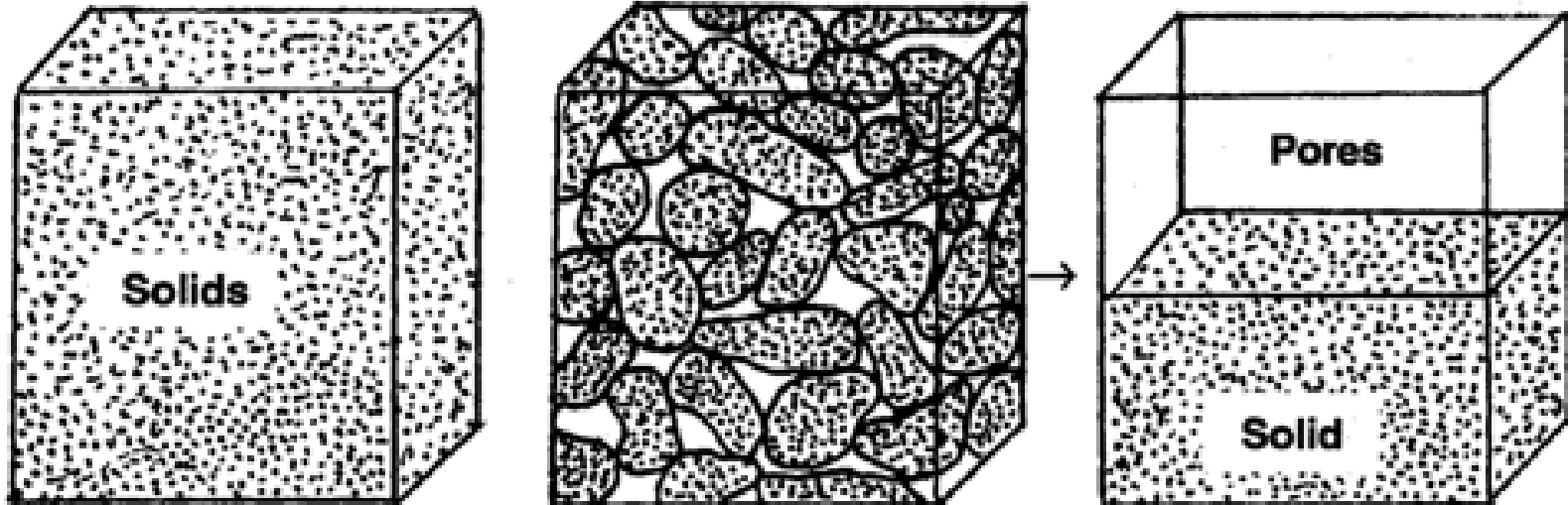

Particle Density

100% solid
Weight = 2.66 g
Volume = 1 cm³

Bulk Density

50% solid, 50% pore space
Weight = 1.33 g
Volume = 1 cm³

Density

The density of a solid particle can assume different values depending on the method used to measure the volume of the particle. It is useful to distinguish three levels of expression of density:

- true (crystal) density,
- particle density,
- apparent density:
 - bulk (loose),
 - tapped density

True density

True density (ρ)

The **true (crystal) density** which only includes the solid fraction of the material.

The crystal density of a substance is the average mass per unit volume, exclusive of all voids that are not a fundamental part of the molecular packing arrangement.

$$\rho = \frac{m}{V}$$

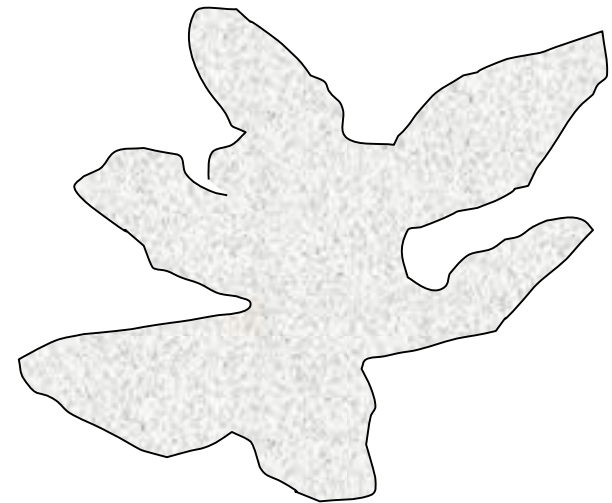

Particle density

Particle density

The particle density includes also the volume due to intraparticulate pores

$$\rho_{sz} = \rho(1 - \varepsilon)$$

ε = porosity

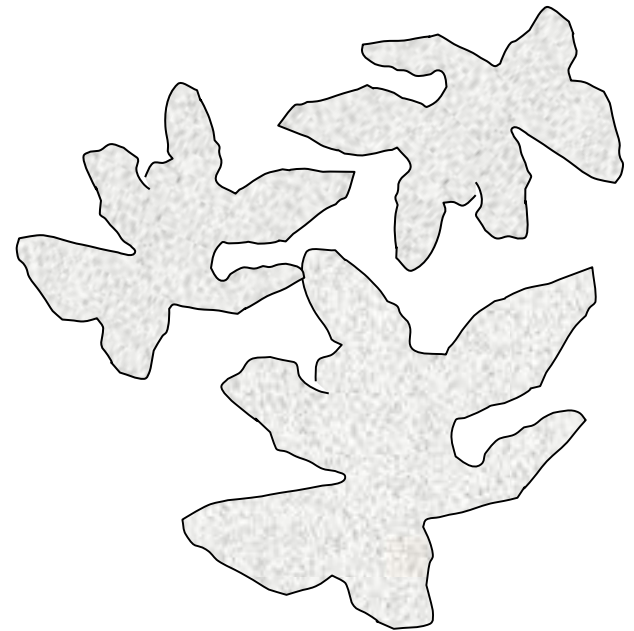

Particle density

Particle density determination

The *pycnometric density* is determined by measuring the volume occupied by a known mass of powder which is equivalent to the volume of gas displaced by the powder using a gas displacement pycnometer.

In pycnometric density measurements, the volume determined includes the volume occupied by open pores ; however, it excludes the volume occupied by sealed pores or pores inaccessible to the gas.

Due to the high diffusivity of helium, which is the preferred choice of gas, most open pores are accessible to the gas.

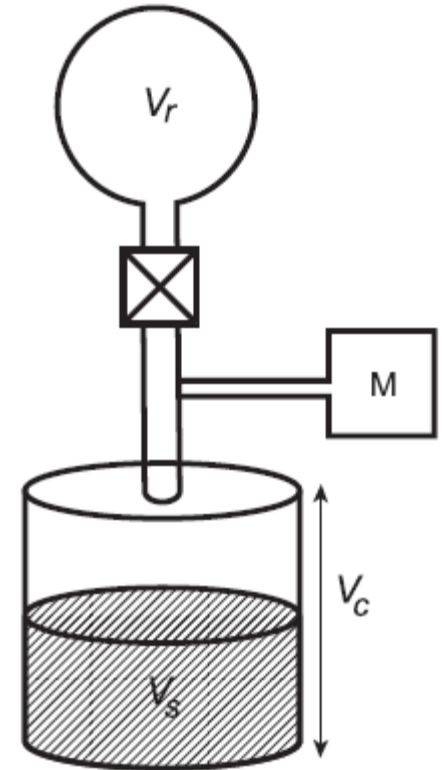

V_r = reference volume

V_c = cell volume

V_s = sample volume

M = manometer

Particle density

Particle density determination
Mercury porosimetry



Particle density

Particle density determination Mercury porosimetry

The relation between the applied pressure and smallest filled pores is:

Washburn equation

$$r = \frac{2\sigma \cos \alpha}{p}$$

r pore radius
 σ the surface tension of mercury
 α contact angle of mercury
 p applied pressure

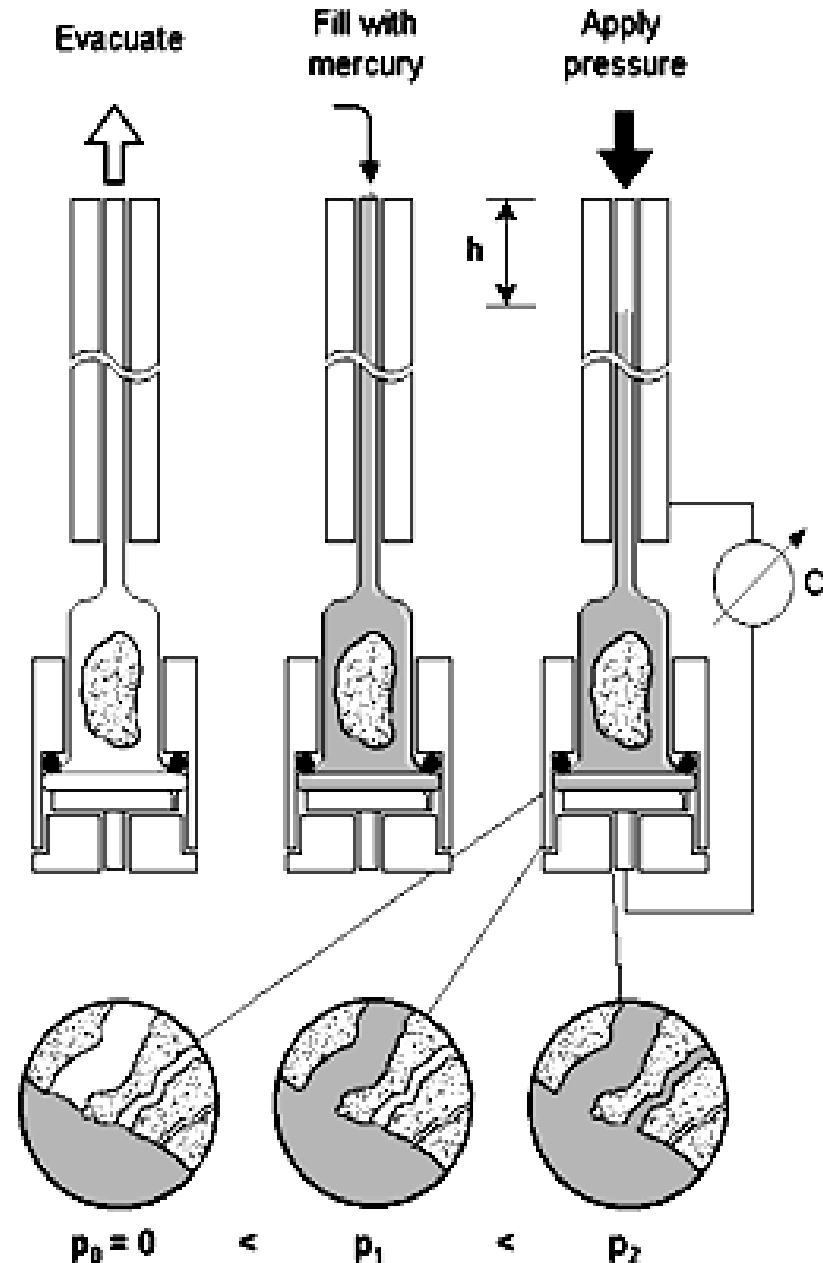

Apparent density

Apparent density

The **apparent (bulk) density** which further includes **the interparticulate void volume** formed in the powder bed.

Known:

- bulked (loose) and
- tapped density.

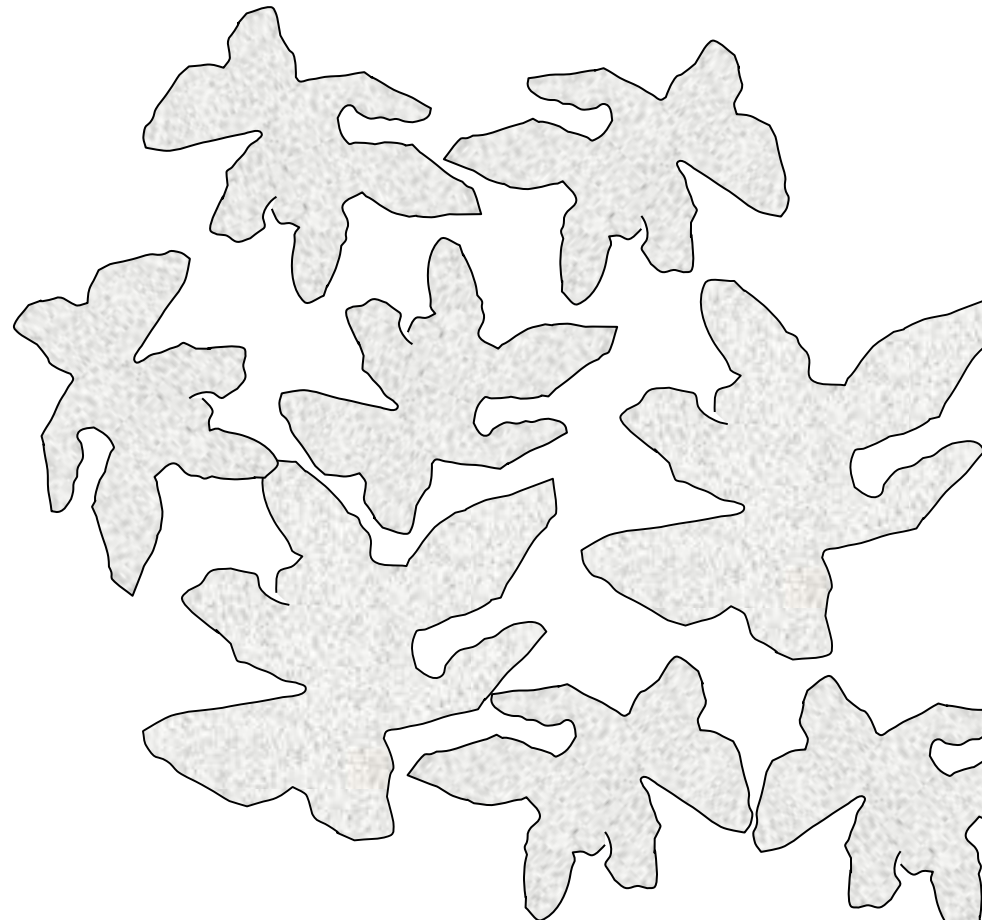

Apparent density



Bulk and tapped density

Apparent density

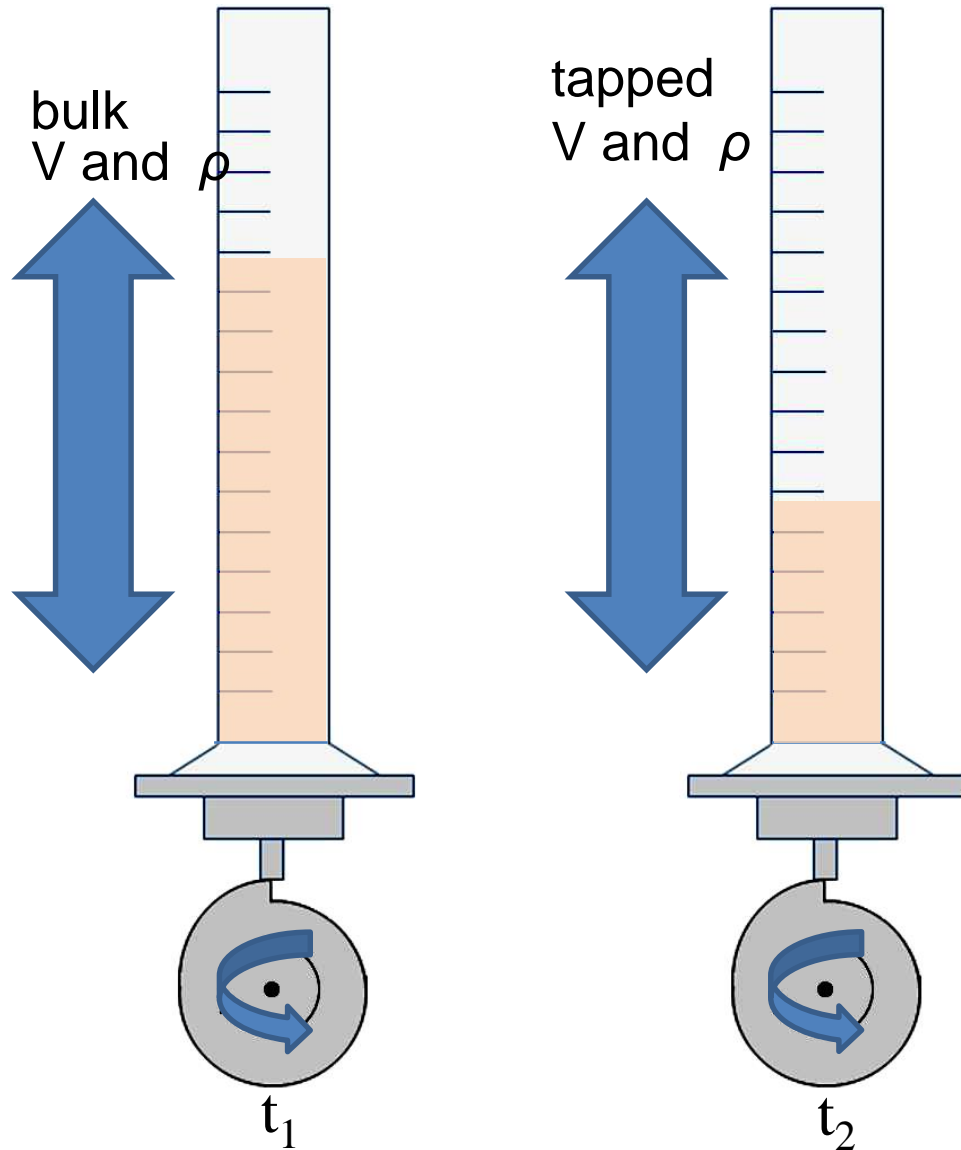

Bulk and tapped density

Tapping

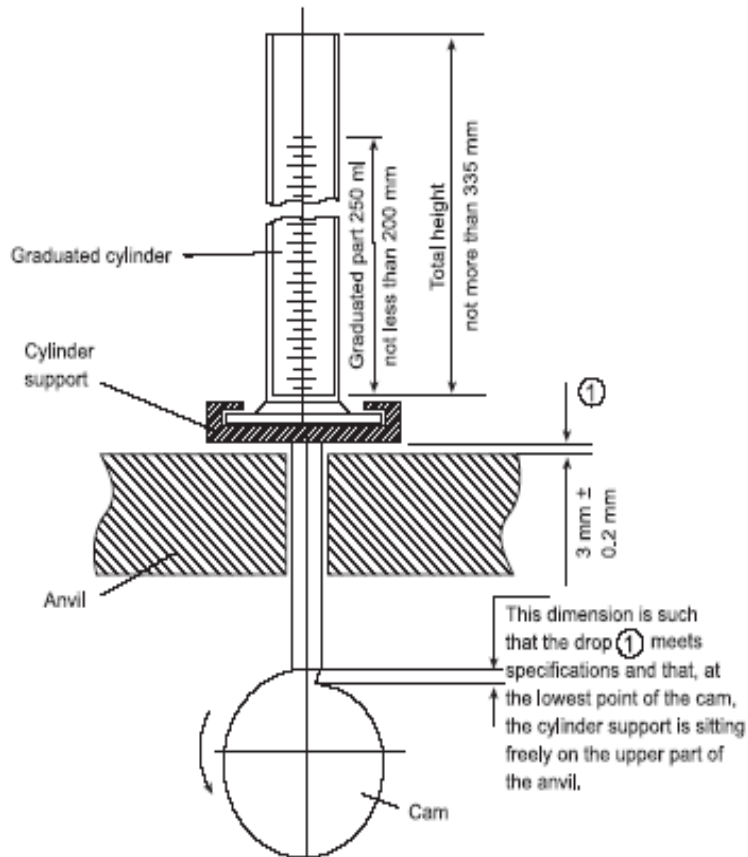

Tapping device:

3 ± 0.2 mm distance

250 ± 15 tap/min

Vol. cylinder:

250 ml / 2 ml scale/

Bulk and tapped density

Apparent density

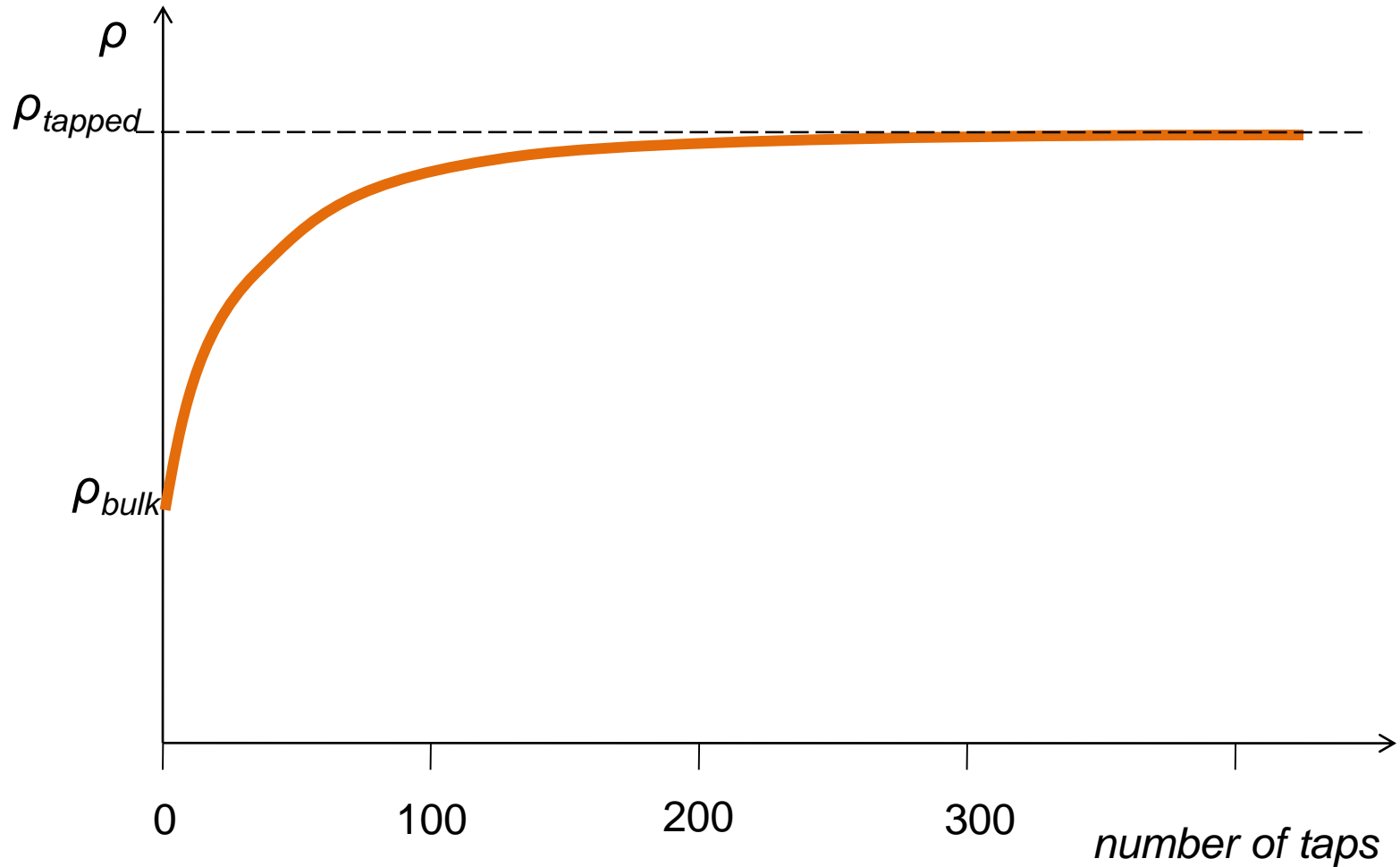

Bulk and tapped density

Tapping

Apparent volume

- Taps: V_{10} , V_{500} and V_{1250} or V_{2500}
 - Measured amount: 100 g or according to the solid characteristics between 50 and 250 ml
 - Bulk volume: V_0 ml
 - Tapped volume: V_{1250} or V_{2500}
 - Ability to settle: $V_{10} - V_{500}$ ml
 - Apparent poured (bulk) density: m/V_0
 - Apparent tapped density: m/V_{1250} or m/V_{2500}

Bulk and tapped density

Hausner factor (H_f)

Ration of compacted and uncompactd volume/density

$$H_f = \frac{\rho_{tapped}}{\rho_{bulk}}$$

$H_f < 1,25$ good flow properties

$H_f = 1,25 - 1,5$ acceptable, but necessary glidants application

$H_f > 1,5$ bad flow properties

Bulk and tapped density

Carr index (C_i)

measures the compaction

$$C_i = 100 \frac{\rho_{bulk} - \rho_{tapped}}{\rho_{bulk}}$$

5-10

excellent

18-21

satisfactory

33-38

wrong

40

no flow

Flowability

Funnel without stem

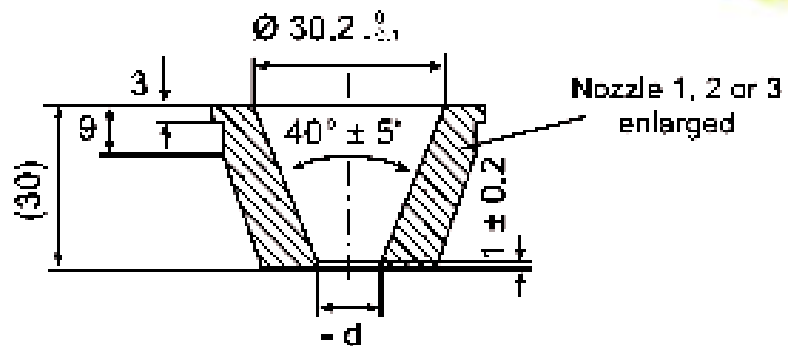
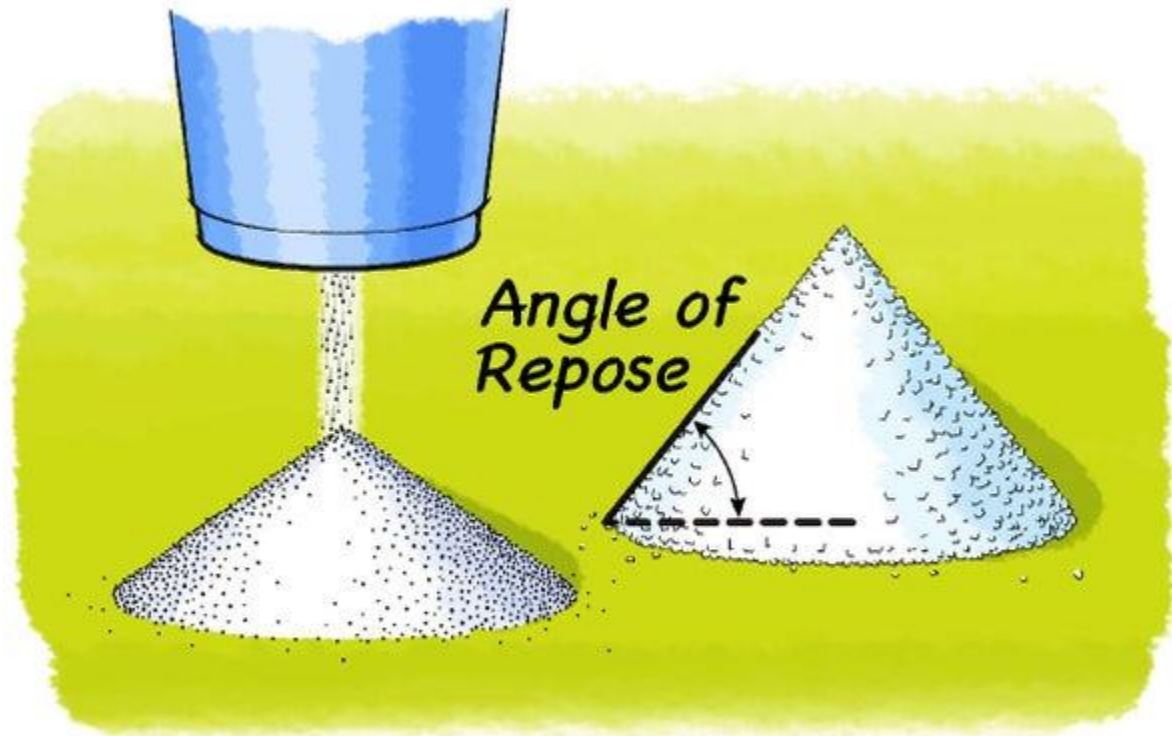
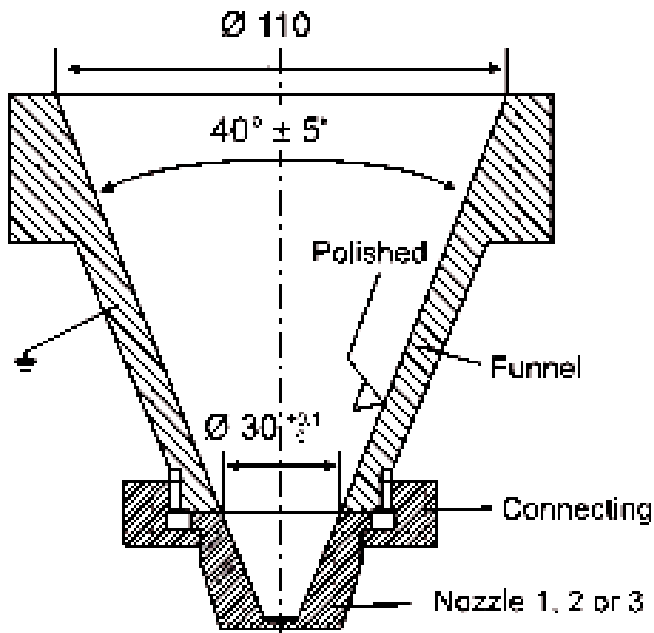

Nozzle	Diameter (d) of the outflow opening (millimetres)
1	10 ± 0.01
2	15 ± 0.01
3	25 ± 0.01

Factors affecting powder flowability

1- Particle size

- Frictional and cohesive forces (resistance to flow) are increased as the particle size is reduced. Very fine particles don't flow as large particles
- In general, particles in the size range of 250-2000 micron flow freely if the shape is agreeable.

Particles in the size range of 75-250 micron may flow freely or cause problems, depending on shape and other factors. With particles less than 100 micron in size, flow is a problem.

2- Density and porosity

- Particles with density and low porosity tend to possess free flowing properties.

Factors affecting powder flowability

3. Particle shape

Rough irregular particles present more points of contact than smooth spherical Particles thus spherical particles flow better than needles.

4. Particle size distribution

Larger amount of fines can inhibit poor flowing

5. Moisture content

Drying the powders will reduce the cohesiveness

Flow through orifice

Measurement of:

- Time
- Weight vs time



Static angle of repose



Static angle of repose

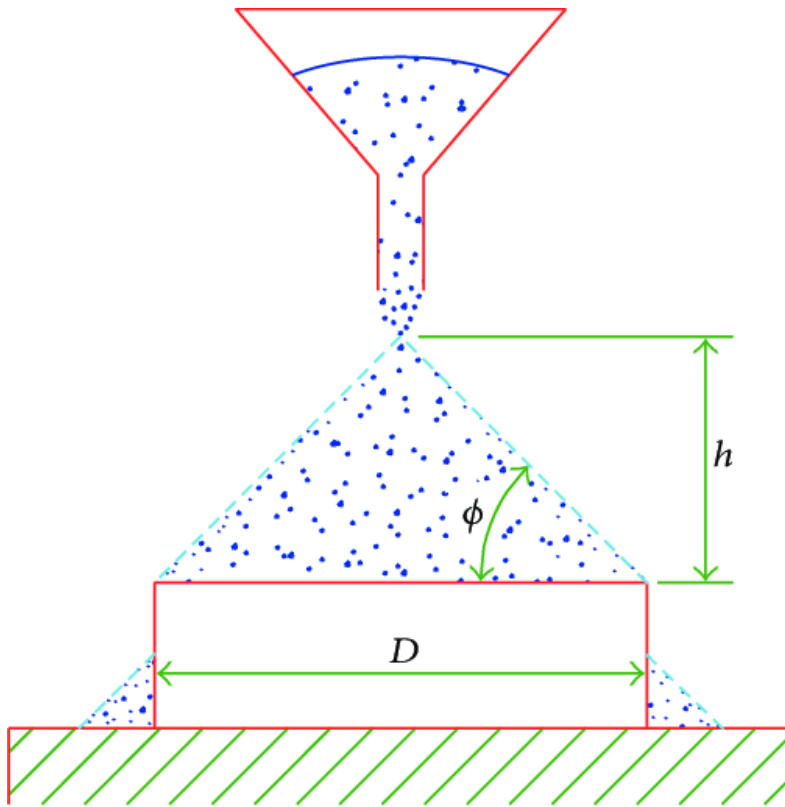

Flow property	Angle of repose (θ)
Excellent	25-30
Good	31-35
Fair-aid not needed	36-40
Passable-may hang up	41-45
Poor-must agitate, vibrate	46-55
Very poor	56-65
Extremely poor	>66

Dynamic angle of repose

Measurement:

- Rotating drum
- Measuring angle of repose

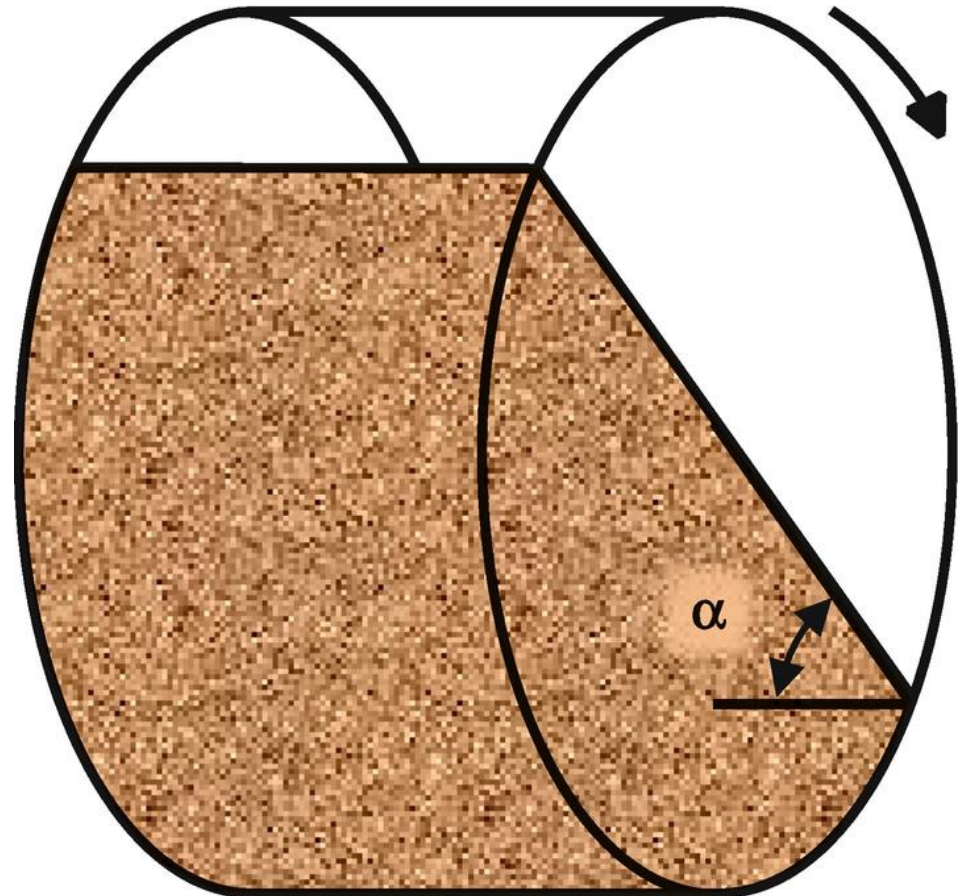

Dynamic angle of repose

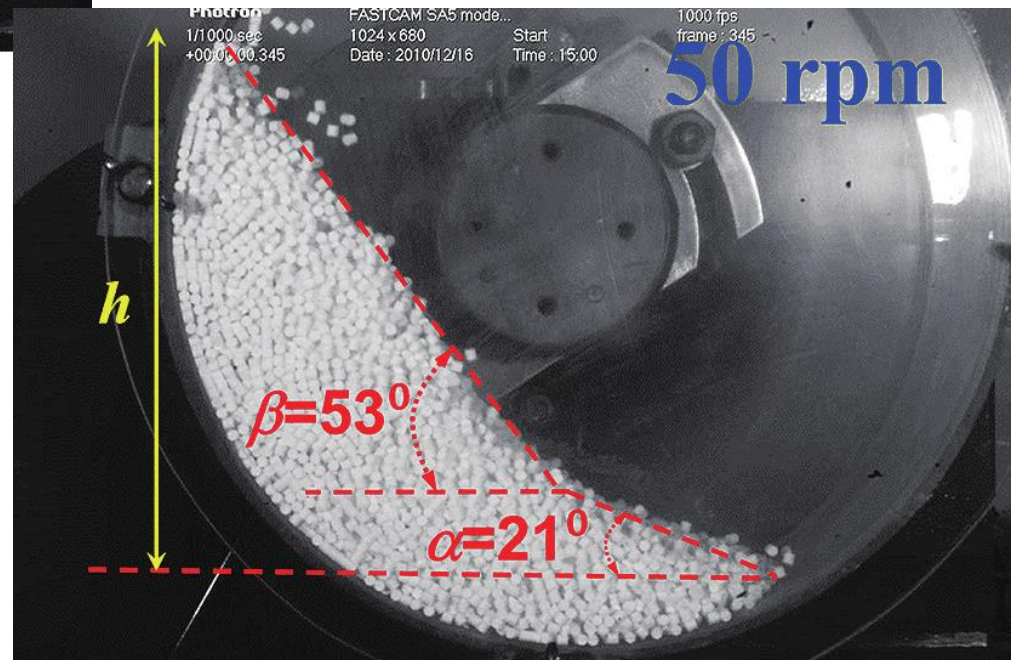
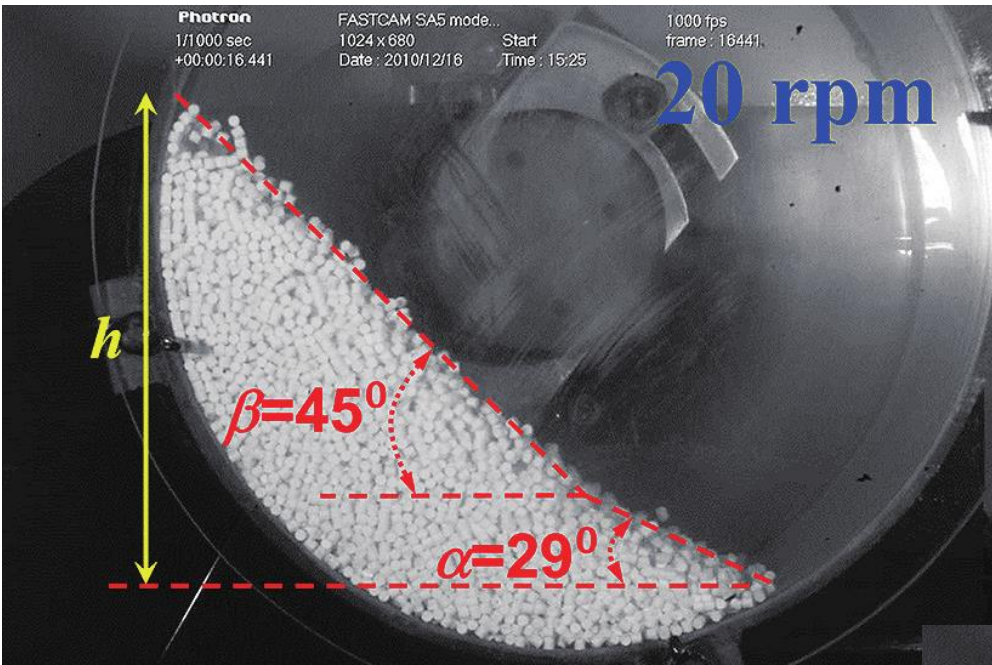

Shear cell method

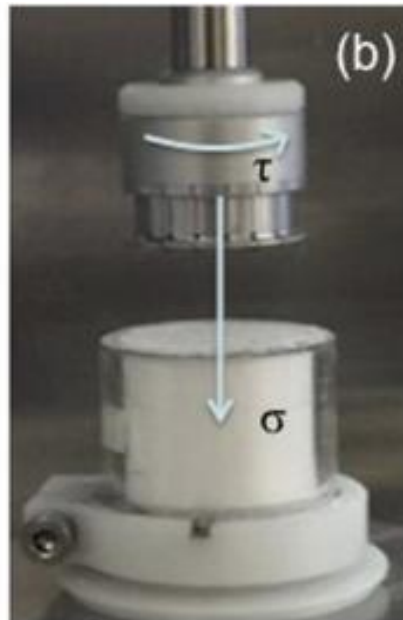
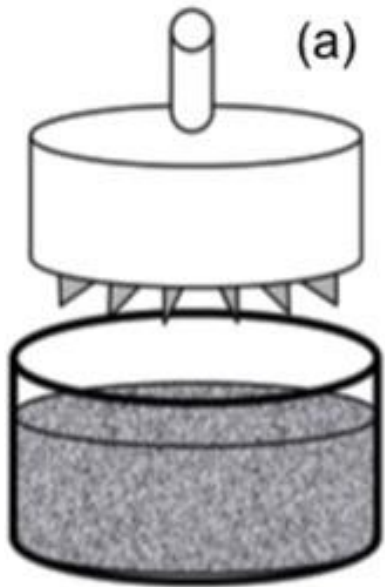

Moisture content

Location of water:

Physically bound: water bridges, capillaries

Adsorbed water

Chemically bound

High moisture content:

- increasing adhesion to the instrument
- insufficient flowability

Low moisture content:

- poor hardness
- electrostatic charge increases
- in case of aerophil substances: layering, capping

Moisture content

Moisture content investigation

- thermobalance
- Karl-Fischer method
- conductometry
- thermal analysis
- NIR

(see Theory and Practice of Pharmaceutical Technology / Dying)

Moisture content

Moisture content investigation

thermobalance



(see Theory and Practice of Pharmaceutical Technology / Dying)

NIR

Near Infrared Spectroscopy

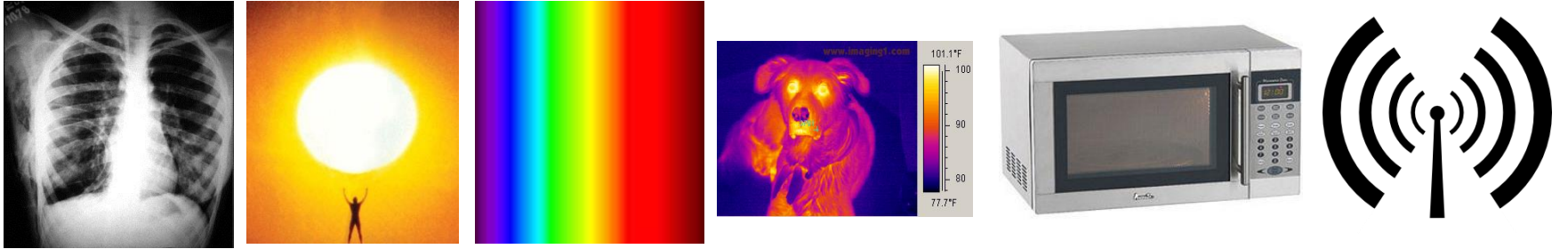

X-RAY 0,2 nm	ULTRA-VIOLET 2 nm	VISIBLE 400-800 nm	INFRARED	MICROVAWE 3 mm-20 cm	RADIO 10 m-30 Km
------------------------	-----------------------------	------------------------------	-----------------	--------------------------------	----------------------------

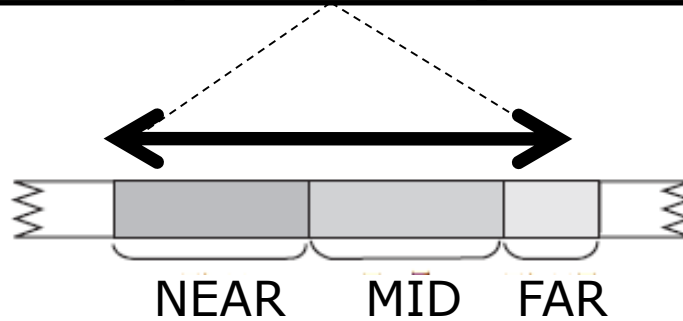

$\lambda, \text{ cm}$ (wavelength)

$\lambda, \text{ cm}^{-1}$ (wavenumber)

7.8×10^{-5} to 3×10^{-4}

12820 to 4000

3×10^{-4} to 3×10^{-3}

4000 to 400

3×10^{-3} to 3×10^{-2}

400 to 33

NIR

Near Infrared Spectroscopy

- Range: 750 – 2500 nm wavelength
- Based on overtones and combination bands of fundamental molecular vibrations
- Absorption is derived from the presence of C-H, N-H and O-H functional groups
- Can be used to determine the ration of water, alcohol, amines and other molecules containing C-H, N-H or/and O-H groups

NIR

Near Infrared Spectroscopy-parts of spectrophotometer

- Optical equipment
 - Light source (pl. tungsten light source)
 - Wavelength switch (prism, filter)
 - Detectors (cooled PbS, germanium, silicone)
 - Integrating sphere for reflectance measurements
 - Sample surface
 - Cell holder
 - Fiber optics for in situ measurements
- Computer (for analysis)

NIR

Near Infrared Spectroscopy-Diffuse Reflectance Spectrum

- NIR spectrophotometer must be equipped with integrating sphere in order to carry out measurements of scattered light from solid surfaces, which gathers the light due to its non-absorbent inner surface coated with MgO or BaSO₄.

NIR Reflectance

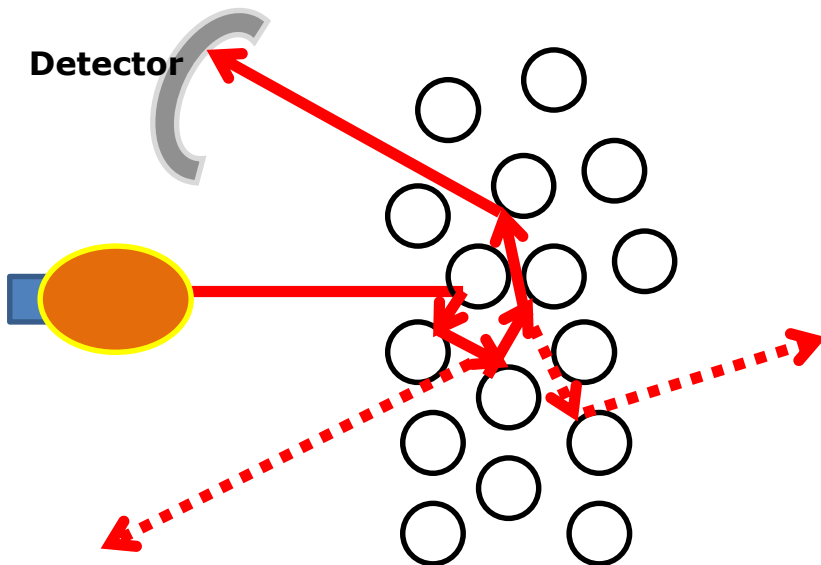

NIR Transmission (NIT)

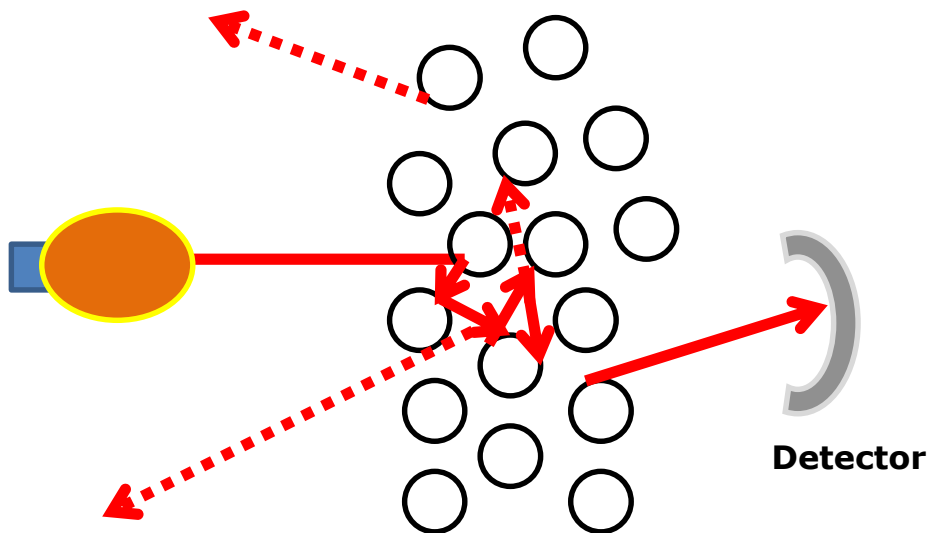

Near Infrared Spectroscopy-advantages

- No pretreatment of the sample
- Chemical and physical data can be obtained from intact samples:
 - particle size,
 - shape,
 - crystallinity,
 - hardness,
 - homogeneity,
 - moisture content,
 - identity, etc.
- Quick analytical method
- Cost effective

Chemical examinations

Institute of Pharmaceutical Technology and Biopharmacy
University of Pécs

Content uniformity

Method. Using a suitable analytical method, determine the individual contents of active substance(s) of **10 dosage units** taken at random.

Tablets complies with the test if each individual content is ± 15 per cent of the average content. The preparation fails to comply with the test if more than one individual content is outside these limits or if one individual content is outside the limits of ± 25 per cent of the average content.



Thank you for the attention!